

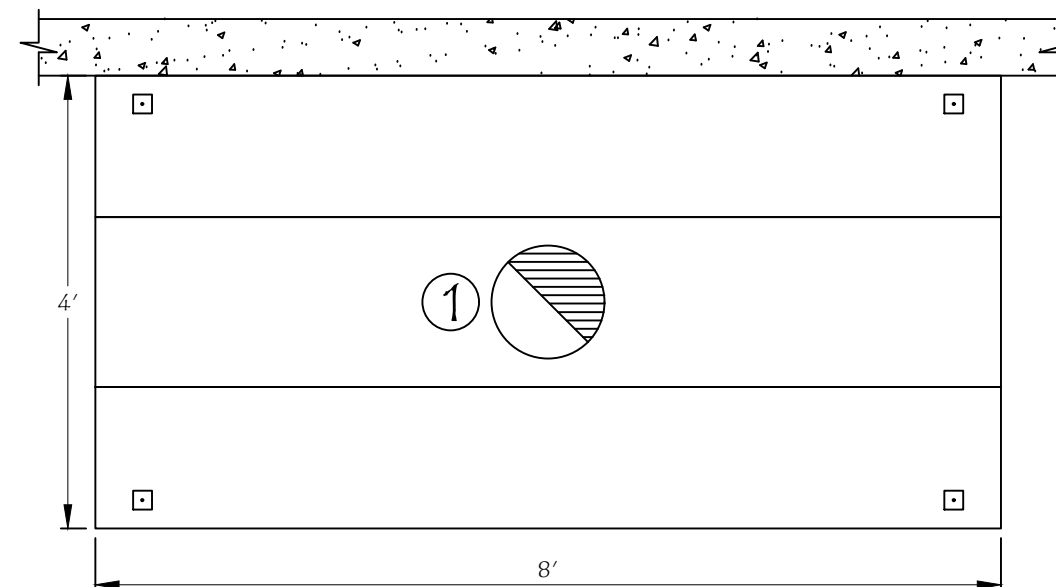

172 REASER COURT PHONE: 440-365-1399 TOLL FREE PH: 800-715-1014 WWW.HOODMART.COM
 ELYRIA, OHIO 44035 FAX: 440-365-2100 TOLL FREE FAX: 800-716-1214 SALES@HOODMART.COM



PLAN VIEW
 SCALE: $\frac{3}{8}'' = 1' - 0''$

HOOD NO.	MODEL	LENGTH	MAX. COOKING TEMP.	① EXHAUST PLENUM					② SUPPLY PLENUM					HOOD CONSTRUCTION
				TOTAL EXH. CFM	RISER(S)				TOTAL SUP. CFM	RISER(S)				
DIA.	QTY.	CFM	S.P.		WIDTH	LENG.	QTY..	CFM		S.P.				
1	TYPE II	96" NOM 96" OD	700 Deg.	1600	12"	1	1600	0.5"	-	-	-	-	-	STAINLESS/ALUMINIZED

DUCT OPENING ARE RECOMMENDED SIZES
 OPENINGS TO BE PUT IN FIELD





172 REASER COURT PHONE: 440-365-1399 TOLL FREE PH: 800-715-1014 WWW.HOODMART.COM
 ELYRIA, OHIO 44035 FAX: 440-365-2100 TOLL FREE FAX: 800-716-1214 SALES@HOODMART.COM

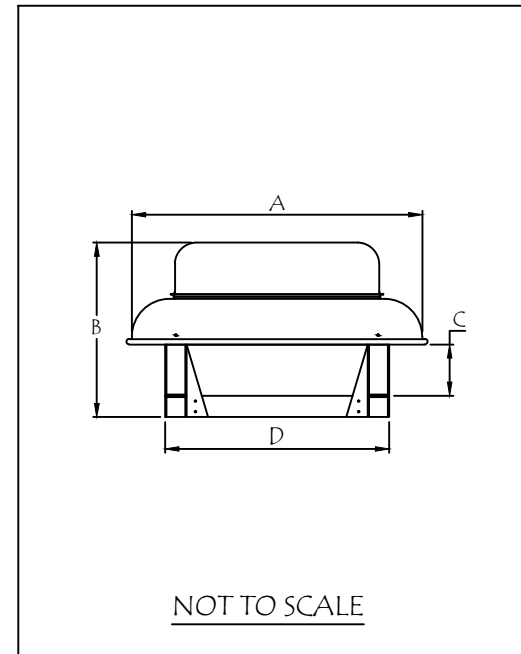

FAN MODEL	A	B	C	D	WT. LBS.
28D-DB	27 ³ / ₄ "	16 ³ / ₈ "	4 ¹³ / ₁₆ "	21" SQ.	41 LBS.

FAN UNIT NO.	FAN UNIT MODEL#	① EXHAUST FAN								
		MODEL	TAG	CFM	S.P.	RPM	H.P.	Ø	VOLTS	FLA
1	28D-DB EF-1	28D-DB	EF-1	1600	0.25"	1725	1/2	1	115	-





172 REASER COURT PHONE: 440-365-1399 TOLL FREE PH: 800-715-1014 WWW.HOODMART.COM
ELYRIA, OHIO 44035 FAX: 440-365-2100 TOLL FREE FAX: 800-716-1214 SALES@HOODMART.COM

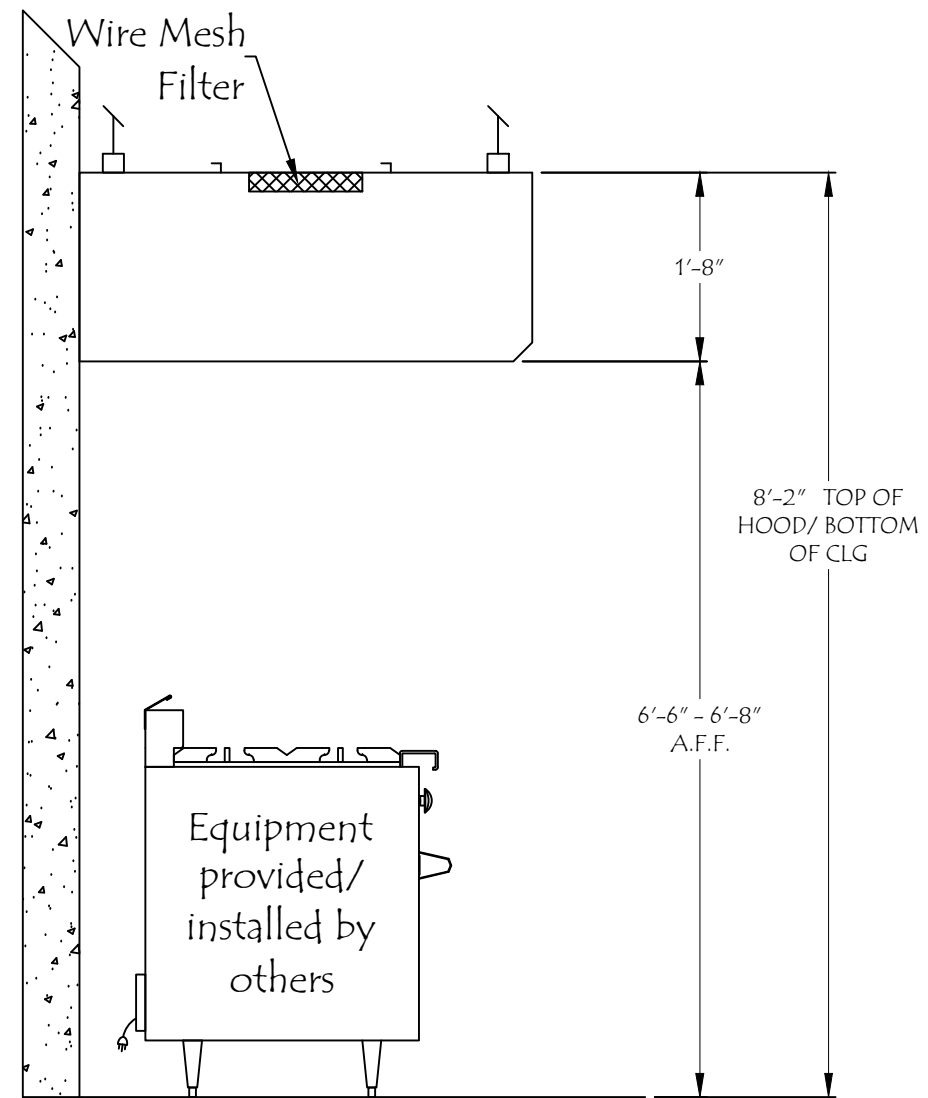

SIDE VIEW - TYPE II
SCALE: $\frac{3}{8}'' = 1' - 0''$

