



ADT130AEWMC6K - SUBMITTAL

Project Name:	NAKS - Cooler Evaporators	Project Location:	
Quote ID:		Item #:	7000
Submitted For:	NAKS	Submitted On:	08/12/2019
Submitted By:		Submitted From:	
Identity #:		Tag:	

For Record For Approval By: _____ Date: _____

General Product Information

Product Family:	ADT	Motor type	EC
Defrost Type:	Air	Number of Fans:	2
Voltage: (Volts/Ph/Hz)	115/1/60	Fan HorsePower	1/15
Refrigerant Type:	R404A	Fins per Inch	6

Technical Information

Performance Data

Capacity			Air Flow				Altitude (ft)	AWEF Value
TD (°F)	SST (°F)	Capacity (BTU/H)	CFM	Fan Diameter (ft)	Air Throw (ft)			
					Standard	w/Collar		
10	25.0	13,000	1,300	12			0	N/A

Electrical Data

Fan Motor(s)		Defrost Heater(s)		Drain Pan Heater(s)	
Watts	Amps	Watts	Amps	Watts	Amps
114	1.8				

Unit Specifications

Connections (in.)						Approx. Net Weight (lbs)
Coil Inlet	Suction	External Equalizer	Drain	Side Port	Hot Gas Drain Pan	
1/2	7/8	1/4	3/4			53

Dimensional Drawing(s)

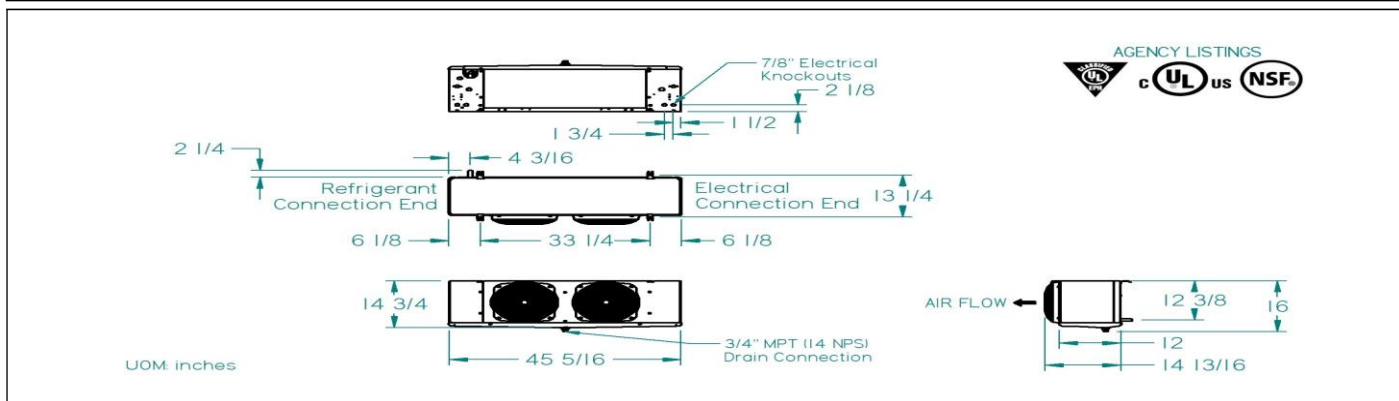



ADT130AEWMC6K - SUBMITTAL

Project Name:	NAKS - Cooler Evaporators	Project Location:	
Quote ID:		Item #:	7000
Submitted For:	NAKS	Submitted On:	08/12/2019
Submitted By:		Submitted From:	
Identity #:		Tag:	

Standard Features

EASE OF INSTALLATION & SERVICE

- ALL ELECTRICAL COMPONENTS FACTORY WIRED TO TERMINAL BOARD AND IDENTIFIED, MAKING IT EASY TO FIELD WIRE THE UNIT
- CABINET DESIGN FEATURES FRONT ACCESS PANELS ON EACH SIDE FOR EASY ACCESS TO ELECTRICAL AND REFRIGERATION COMPONENTS
- LIQUID LINE SOLENOID WIRE HARNESS IS FACTORY-INSTALLED FOR QUICK INSTALLATION
- MOTORS PLUG INTO WIRING HARNESS FOR EASIER SERVICING
- ON 4-6 FAN MODELS, DRAIN PAN HAS A LANYARD FOR EASY AND SAFE ACCESS
- PRE-DRILLED HOLES ON THE BACK OF THE UNIT FOR ROOM THERMOSTAT

RELIABLE & DURABLE

- HEAVY GAUGE GRAINED ALUMINUM CABINET CLEANS EASILY AND LOOKS ATTRACTIVE
- MOLDED FAN GUARD DESIGN MADE OF STRONG PLASTIC MATERIAL
- SWEAT CONNECTIONS TO REDUCE POTENTIAL FOR LEAKS

PERFORMANCE

- INTERNAL PANELS ARE ISOLATED FOR QUIET OPERATION
- INTERNALLY ENHANCED TUBING AND FIN DESIGN FOR HIGHER EFFICIENCY

VERSATILE

- LARGE DIAMETER DRAIN HOLE (3/4" ID) IS LOCATED ON THE BACK OF THE UNIT
- MINIMAL HEIGHT OF THE LOW PROFILE SERIES MAKES IT IDEAL FOR LOW CEILING COOLERS

Options

Mounted Options

- Variant condition - null
- COIL COATING - ALUMINUM
- CONTROLS - NONE
- VOLTAGE ASSEMBLY SELECTION - 115V EC
- CARTON OPTIONS - STANDARD CARTON
- NOZZLE SELECTIONS - NOZZLE INSTALLED
- COIL SELECTION - MOUNTED TXV & SOL
- COIL MECHANICAL OPTION - LLSV AND TXV
- NAMEBRAND SELECTION - BOHN
- FAN BLADE SELECTION - STANDARD FAN BLADE
- FAN GUARD SELECTION - BOHN PLASTIC GUARD
- ELECTRICAL OPTIONS - FRNT ACC WTR T'STAT 115V W/MTD

Minimum Unit Clearances

