

## Installation and Service Manual

Direct-Fired Make-Up Air Units

### T-Series

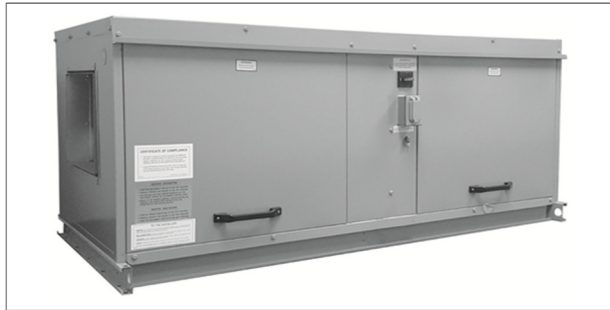

## ⚠ WARNING ⚠

Improper installation, adjustment, alteration, service or maintenance can cause property damage, injury or death, and could cause exposure to substances which have been determined by various state agencies to cause cancer, birth defects, or other reproductive harm. Read the installation, operating, and maintenance instructions thoroughly before installing or servicing this equipment.

## FOR YOUR SAFETY

The use and storage of gasoline or other flammable vapors and liquids in open containers in the vicinity of this appliance is hazardous.

If You smell Gas:

1. Open windows (indoor installation only).
2. Do not touch electrical switches.
3. Extinguish any open flame.
4. Immediately call your gas supplier.

## IMPORTANT

The use of this manual is specifically intended for a qualified installation and service agency. A qualified installation and service agency must perform all installation and service of these appliances.



T-Series is ETL certified to meet the U.S. and Canadian requirements in the latest version of ANSI Standard Z83.4, Non-Recirculating Direct Gas-Fired Industrial Air Heaters.

### Inspection upon arrival

1. Inspect the unit upon arrival. In case of damage, report it immediately to transportation company and your local NAKS, Inc. representative.
2. Check the rating plate on the unit to verify the power supply meets available electric power at the point of installation.
3. Inspect the unit upon arrival for conformance with description of product ordered (including specifications where applicable).

### **SPECIAL PRECAUTIONS**

THE INSTALLATION AND MAINTENANCE INSTRUCTIONS IN THIS MANUAL MUST BE FOLLOWED TO PROVIDE SAFE, EFFICIENT AND TROUBLE-FREE OPERATION. IN ADDITION, PARTICULAR CARE MUST BE EXERCISED REGARDING THE SPECIAL PRECAUTIONS LISTED BELOW. FAILURE TO PROPERLY ADDRESS THESE CRITICAL AREAS COULD RESULT IN PROPERTY DAMAGE OR LOSS, PERSONAL INJURY, OR DEATH. THESE INSTRUCTIONS ARE SUBJECT TO ANY MORE RESTRICTIVE LOCAL OR NATIONAL CODES.

### **HAZARD INTENSITY LEVELS**

1. **DANGER:** Indicates an imminently hazardous situation which, if not avoided, WILL result in death or serious injury.
2. **WARNING:** Indicates a potentially hazardous situation which, if not avoided, COULD result in death or serious injury.
3. **CAUTION:** Indicates a potentially hazardous situation which, if not avoided, MAY result in minor or moderate injury.
4. **IMPORTANT:** Indicates a potentially hazardous situation which, if not avoided, MAY result in minor or moderate injury.

### **DANGER**

Appliances must not be installed where they may be exposed to a potentially explosive or flammable atmosphere.

### **CAUTION**

1. Purging of air from gas supply lines should be performed as described in ANSI Z223.1 – latest edition "National Fuel Gas Code", or in Canada in CAN/CGAB149 codes.
2. Since a failure of the unit may affect the proper operation of other fuel burning equipment in the building, the unit shall be electrically interlocked to open balancing air inlet dampers, or other such devices.
3. Do not operate unit with a gas input rate greater than that shown on the unit rating plate.
4. When using a drill bit to clean the burner gas ports, do not distort or enlarge the ports. Do not use a power drill.
5. Ensure the supply voltage to the appliance, as indicated on the serial plate, is not 5% less than the rated voltage.
6. Do not reuse any mechanical or electrical component which has been wet. Such components must be replaced.

### **WARNING**

1. Failure to follow proper lifting instructions could result in property damage, serious injury, or death. Lifting should only be done by a qualified rigging company. Use ALL lifting points. Test lift to ensure proper balance and rigging. Never lift in high winds.
2. All field gas supply lines should be pressure/leak tested prior to operation. Never use an open flame. Use a soap solution or equivalent for testing.
3. Gas pressure to the unit controls must never exceed pressure shown on the unit's rating plate. The unit and its individual shutoff valve(s) must be disconnected from the gas supply during any pressure in excess of 0.5 psig (3.5 kPa).

4. For test pressure less than 0.5 psig (3.5 kPa), the unit gas control must be isolated from the supply gas piping by closing the unit manual shutoff valve(s).
5. For indoor units, where required by Code, use a dedicated line for venting gas to the outside of the building.
6. Disconnect power supply before making wiring connections to prevent electrical shock and equipment damage.
7. If equipped with the factory installed Disconnect Switch option, when the switch is in the "OFF" position, supply power remains energized at the supply power terminal strip and the top of the disconnect switch. When providing service on or near these terminals, building supply power to the unit should be de-energized.
8. All appliances must be wired strictly in accordance with the wiring diagram furnished with the unit. Any wiring that is different from the wiring diagram could result in a hazard to persons and property.
9. Any original factory wiring that requires replacement must be replaced with wiring material having a temperature rating of at least 105°C.
10. Ensure the supply voltage to the appliance, as indicated on the serial plate, is not 5% greater than the rated voltage.
11. When servicing or repairing this equipment, use only factory-approved service replacement parts. A complete replacement parts list may be obtained by contacting NAKS, Inc., Inc. Refer to the rating plate on the unit for complete appliance model number, serial number, and company address. Any substitution of parts or controls not approved by the factory will be at owner's risk.

### **IMPORTANT**

Start-up and adjustment procedures should be performed by a qualified service agency.  
To check most of the Possible Remedies in the troubleshooting guide (pgs. 27-28), refer to the applicable sections of the manual. Installation in an airplane hangar must be in accordance with the Standard for Aircraft Hangars, ANSI/ NFPA 409, and (2) public garage in accordance with the Standard from Parking Structures, ANSI/NFPA 88A, or the Standard for Repair Garages, ANSI/NFPA 88B and with CAN/CGA B149 Installation Codes.  
  
Adequate building relief must be provided so as to not over-pressurize the building when the heating system is operating at its rated capacity. This can be accomplished by taking into account, through standard engineering methods, the building structure design infiltration rate; by providing proper sized relief openings; by interlocking a power exhaust system; or by a combination of these methods.

The heater inlet shall be located in accordance with the applicable code provisions for ventilation air.  
Field constructed intake accessories should be properly designed and installed to minimize the entry of snow and rain.  
All air to the unit must be ducted directly from the outdoors.  
Recirculation of room air is not permitted through the burner.  
If in doubt regarding the application, contact your local NAKS, Inc. Representative.

## TABLE OF CONTENTS

Unit Location	4
Location Recommendations	4
Sound and Vibration Attenuation	4
Mounting Options	5
Suspended Units	5
Rail Mounted Units	5
Slab Mounted Units	5
Roof Curb Mounted Units	5
Roof Curb Installation	5
Rigging Instructions	6
Unit Installation	6-8
Duct Installation	6
Gas Connections	7
Manifold Arrangements/Compliance	7
Electrical Connections	8
Prior Start-Up/Operation	8
Unit Features	9-17
Unit Features - Control Cabinet	9-11
Unit Features - Blower Cabinet	12
Unit Features - Optional Side Access Filter Section	13
Unit Features - Optional Evaporative Cooler	14-15
Accessories - Field Installed - Remote Panel/Other	16-17
Start-Up Procedure	18-23
Before Performing the Start-Up	18
Pre-Start-Up Inspection	18
Performing the Start-Up	18-21
Verify the Auto-Profile System Operation	21
Blower/Motor Adjustment	21
Setting the Dirty Filter Switch	22
Commissioning/Sequence of Operation	22-23
Final Step	23
Unit and Accessory Weights	24
Maintenance	25-26
Service and Troubleshooting	27-28
Start-up Checklist and Report	29-36
Replacement Parts Ordering	37
Serial Plate Example	37
Terms and Condition of Sale	38
Warranty	39

## UNIT LOCATION

### DANGER

Appliances must not be installed where they may be exposed to a potentially explosive or flammable atmosphere.

### LOCATION RECOMMENDATIONS

1. Do not locate any gas-fired equipment where chlorinated, halogenated or acid vapors are present in the combustion air atmosphere.
2. When locating the unit, consider general space and heating requirements and availability of gas and electrical supply.
3. Where necessary to provide working clearance beneath the unit, the unit shall be installed at a suitable height above the floor or otherwise adequately protected.
4. Ensure the structural support for the unit location is adequate to support the weight of the unit.
5. For economical installation and operation, locate each unit close to the space it will serve, and close to the utilities that will serve the unit.
6. Adequate building relief must be provided so as to not over pressurize the building when the heating system is operating at its rated capacity. This can be accomplished by taking into account, through standard engineering methods, the building structure design infiltration rate; by providing proper sized relief openings; by interlocking a power exhaust system; or by a combination of these methods.
7. The heater inlet shall be located in accordance with the applicable code provisions for ventilation air.
8. All air to the unit must be ducted directly from the outdoors. Recirculation of room air is not permitted through the burner.
9. Ensure sure the minimum clearances to combustibile material and recommended service clearances are maintained. The unit is designed for installation on non-combustible surfaces or combustibile surfaces with the minimum clearances shown in Table 4.1.
10. Field constructed intake accessories should be properly designed and installed to minimize the entry of snow and rain.
11. If in doubt regarding the application, contact your local NAKS, Inc. Representative.

TABLE 4.1 - COMBUSTIBLE MATERIAL AND SERVICE CLEARANCES

Models	Minimum clearance to combustibile materials				Minimum clearance for service access (both sides)
	Top	Bottom	Sides	Ends	
All	6"	6"	6"	6"	36"

## SOUND AND VIBRATION ATTENUATION

All mechanical equipment generates some sound and vibration which may require attenuation. Locate the equipment away from critical areas whenever possible. Frequently, the unit can be mounted above utility areas, corridors, restrooms, and other non-critical areas. Generally, the unit should be located within 15 feet of a primary support beam. Smaller deflections mean less vibration and noise transmission.

For roof curb-mounted units, Figure 4.1 shows suggested methods of sound attenuation. Field-installed vibration isolators are available for a suspended or rail or slab mounted unit. Refer to Figures 4.2 and 4.3.

FIGURE 4.1 – SUGGESTED SOUND ATTENUATION

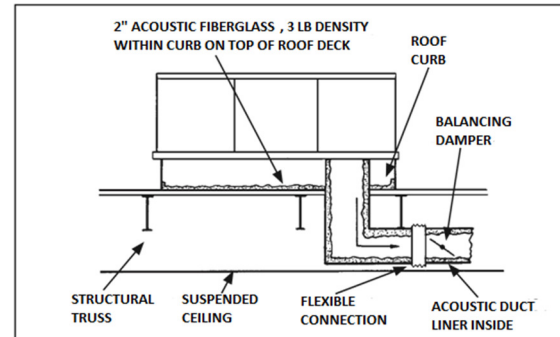

FIGURE 4.2 - VIBRATION FEET (SLAB OR RAIL MOUNTED UNITS)

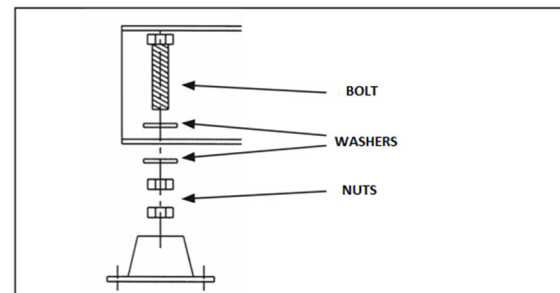
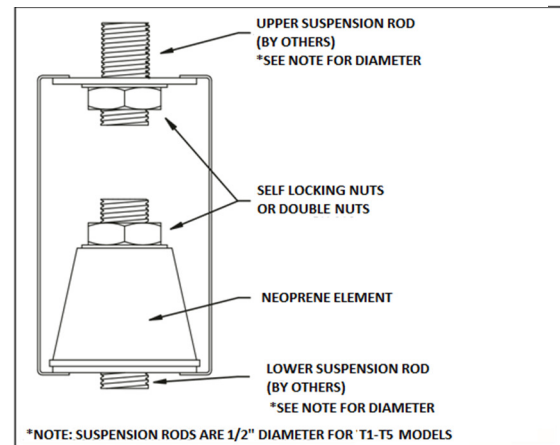

FIGURE 4.3 - VIBRATION HANGERS (SUSPENSION UNITS)



## MOUNTING OPTIONS

### Unit Installation

Prior to installing the unit in the final location, review the following:

1. Follow site preparation instructions for applicable unit mounting method. Covered in this section are suspended, rail mounted, slab mounted, and curb mounting recommendations.
2. Check the rating plate of the unit before lifting to ensure that the model number shown matches that shown on the plans. Although the unit may look similar, their function, capacities, options, and accessories may vary widely.
3. Check the unit dimensions for proper fit.

Follow proper rigging instructions on page 6.

### Suspended

Ensure the structure from which the unit and accessories are hung is adequate to handle the weight, which can be found on page 24. The unit must be level in a horizontal position.

Combination lifting and support points are supplied with each unit. Refer to Figure 5.1 for the recommended mounting method.

FIGURE 5.1 - UNIT SUSPENSION

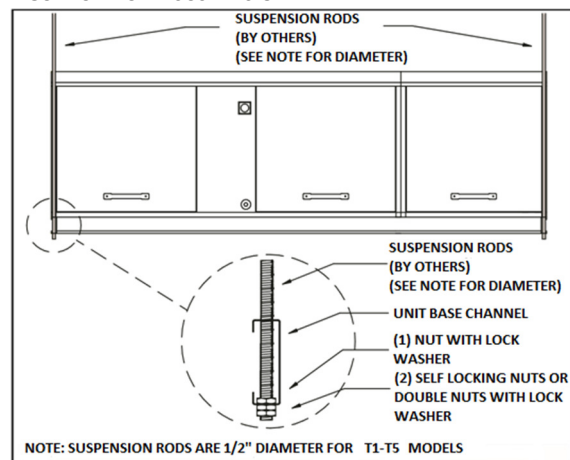

### Rail Mounting

If mounting on a roof, the roof structure must be adequately designed to support the live weight load of the unit and rail mounting support structure. Use two continuous rails for the length of the unit (in direction of air flow) as shown in Figure 5.2. The unit must be level in a horizontal position

FIGURE 5.2 - UNIT RAIL SUPPORTS

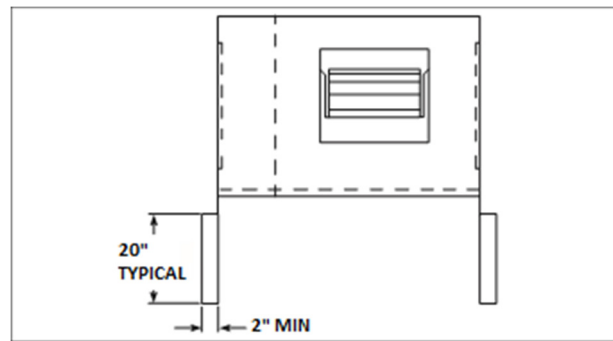

### Slab Mounting

For ground level installation of the unit, prepare a horizontally level concrete slab at least 4" thick, which extends 6 inches beyond the unit on all sides. The slab should include an adequate footing and a bed of gravel for proper drainage. The slab should include 1/2" threaded anchor bolts spaced according to the anchor holes in the unit base. The anchor bolts should extend at least 4-1/2" above the surface of the slab to allow clearance for mounting washers, bolts, and nuts (provided by others).

### Roof Curb Mounting

An optional 20" high roof curb is available to simplify site preparation and to raise the unit above roof water and snow levels. It can be installed on the roof in advance of the unit. The curb is shipped knocked down with separate instructions for its assembly, flashing, and sealing with the roof. Refer to Figure 5.3.

FIGURE 5.3 - TYPICAL ROOF CURB DETAILS

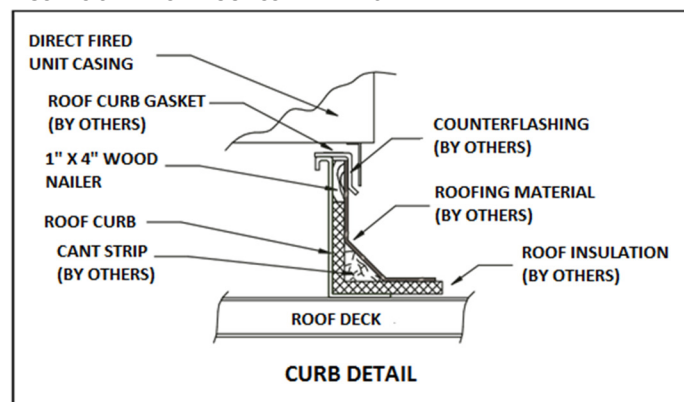

### Roof Curb Installation

1. The roof structure must be adequately designed to support the live weight load of the unit and any other support structure. The roof curb should be supported at points no greater than five feet apart. Additional truss reinforcement should be provided, if necessary.
2. Maintain an 8" minimum height from the top of the roof deck to the top of the curb.

3. Outside curb dimensions must be held when installing the curb. The top of the curb must be level to insure weather tightness. All corners must be square.
4. Thoroughly clean and dry the top of the curb surface.
5. Caulk or use gasket around the top perimeter of the curb.
6. Following the Rigging Instructions in the next section, lift the unit into place and set the unit down evenly on curb.

7. If the unit is supplied with accessories for field-mounting, attach all accessories after the unit has been set into place.
8. Final electric and gas connections must be made after the unit is installed to allow for tolerance in setting of the unit on the curb. Instructions for these connections are covered in a later section of this manual.

## RIGGING INSTRUCTIONS / DUCT INSTALLATION

### WARNING

Failure to follow proper lifting instructions could result in property damage, serious injury, or death. Lifting should only be done by a qualified rigging company. Use ALL lifting points. Test lift to ensure proper balance and rigging. Never lift in high winds.

1. Each unit is supplied with four mounting and lifting brackets, integral to the unit base, with holes for lifting hooks.
2. When lifting the equipment, connect steel cables, chains, or straps with eye loops as illustrated in Figure 6.1.
3. For stability in lifting and lowering and to prevent damage to the unit, include a spreader bar as illustrated in Figure 6.1.
4. Avoid twisting or uneven lifting of the unit. The cable length from the lifting point on the unit to the spreader bar should always be longer than the distance between the outer lifting points.
5. For units with inlet accessories shipped separately, it is recommended that the unit and accessories be lifted separately and the accessories assembled to the unit after the unit is set in place.

FIGURE 6.1 - TYPICAL RIGGING

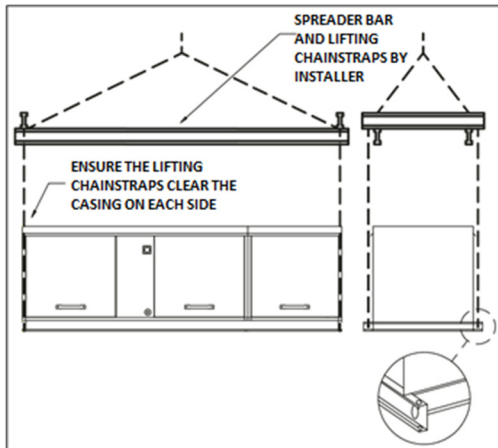

To assure proper air flow from the discharge of the unit, follow these recommendations.

1. Ensure the discharge duct is properly sized for the airflow.
2. As a general rule, the discharge duct should have a straight run of at least three (3) duct diameters (Dh) before making turns in the ductwork.

For rectangular ducts:  $dh = 4a/P$  For circular ducts:  $dh = d$  where:

a = cross sectional area of rectangular duct

P = Perimeter of rectangular duct

d = diameter of round cut

3. Figure 6.2 shows the recommended duct layout for various discharge ductwork.
4. Where ductwork (or other enclosure) is installed to the inlet or outlet of the unit in such a way as to cause a possible gas trap and accumulation of a flammable mixture, a pre-purge cycle shall be incorporated to provide not less than 4 complete air changes to the ductwork (or enclosure) by volume prior to an ignition attempt.
5. Fire dampers (supplied by others) installed in the inlet or outlet duct systems shall be provided with electrical interlocks connected in the safety limit control circuit s so as to cause the heater to shut down in case of fire in the ductwork the or unit. The electrical interlocks must be so arranged that the safety circuit is electrically energized only when the fire damper is in the wide-open position.

FIGURE 6.2 - TYPICAL DISCHARGE DUCT CONFIGURATIONS

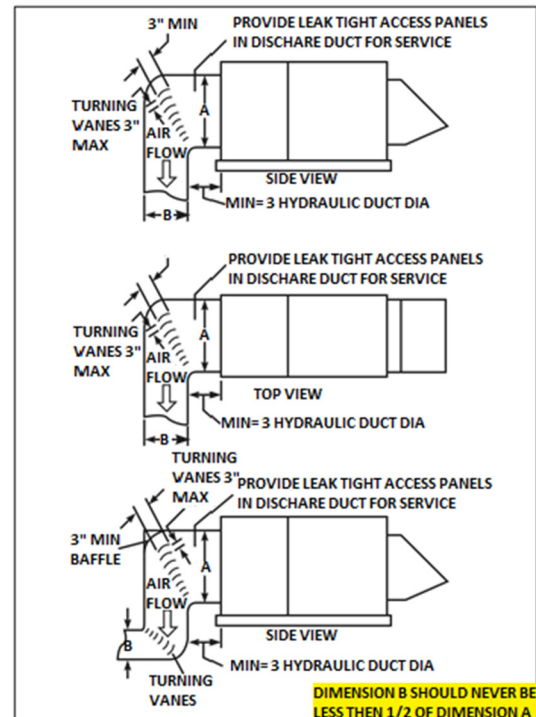

# UNIT INSTALLATION

## Gas Connections

### WARNING

1. All field gas supply lines should be pressure/leak tested prior to operation. Never use an open flame. Use a soap solution or equivalent for testing.
2. Gas pressure to the unit controls must never exceed the pressure shown on the unit rating plate. The unit and its individual shutoff valve(s) must be disconnected from the gas supply during any test pressure in excess of 0.5 psig (3.5 kPa).
3. For test pressure less than 0.5 psig (3.5 kPa), the unit gas control must be isolated from the supply gas piping by closing the unit manual shutoff valve(s).
4. For an indoor unit, where required by Code, use a dedicated line for venting gas to the outside of the building.

### CAUTION

Purging of air from gas supply lines should be performed as described in ANSI Z223.1-latest edition "National Fuel Gas Code" or in Canada in Can/CGA-B149 codes.

1. Installation of piping must be in accordance with local codes, and ANSI Z223.1-latest edition, "National Fuel Gas Codes". (In Canada CAN/CGA-B149 Code).
2. Piping to the unit must conform to local and national requirements for type and volume of gas handled, and pressure drop allowed in the line. Refer to the unit rating plate to determine the Btu capacity of the unit and the type of gas the unit is designed to use. Using this information, refer to the ASHRAE Guide Fundamentals Handbook, or other gas pipe sizing guide, to determine the correct supply pipe size. Allow sufficient pipe size based on allowable pressure drop in supply line. Where several units are served by the same main, the total capacity of all the units served by the main must be used. Do not use pipe sizes smaller than 1/2".
3. Pipe size to the unit must match the factory side access gas connection size, as shown in Table 7.1.

**TABLE 7.1 - FIELD GAS SUPPLY CONNECTIONS**

Manifold Size	Connection Pipe Size	Inlet Pressure Range
1/2"	1/2"	7-14" wc
3/4"	3/4"	8-14" wc
1"	1"	0.5-1 psig
1-1/4"	1-1/4"	0.5-5 psig

4. Install a ground joint union with brass seat and a manual shut-off valve external to the unit casing, as shown in Figure 7.1, adjacent to the unit for emergency shut-off and easy servicing of controls. Include a 1/8" NPT plugged tapping accessible for test gauge connections.

5. Provide a sediment trap, as shown in Figure 7.1 before each unit and where low spots in the pipe line cannot be avoided.
6. This unit requires a constant minimum gas supply pressure when the unit is operating at maximum gas flow. Refer to Table 7.1 for the allowable range. If the gas supply pressure exceeds the range shown in Table 7.1, a gas pressure regulator must be installed before the unit to prevent damage to the internal valve components. If the pressure is lower than the range shown in Table 7.1, the heater may not perform to specifications.
7. Support piping so that no strains are imposed on the unit controls when connected.
8. Blow out the gas line to remove debris before making connections.
9. Purge the gas line to remove air before attempting to start unit. Purging of air from gas lines should be performed as described in ANSI Z223.1-latest edition "National Fuel Gas Code", or in Canada in CAN/CGA-B149.
10. All field gas piping must be pressure/leak tested prior to unit operation. Use a non-corrosive bubble forming solution or equivalent for leak testing. The heater and its individual shut-off valve must be disconnected from the gas supply piping system during any pressure testing of that system at test pressures in excess of 0.5 psig. The heater must be isolated from the gas supply piping system by closing its individual manual shutoff valve during any pressure testing of the gas supply piping system at test pressures equal to or less than 0.5 psig.
11. Weatherize all utility clearance holes on the unit after connections have been made.

**FIGURE 7.1 - REQUIRED PIPING TO UNIT GAS CONTROLS**

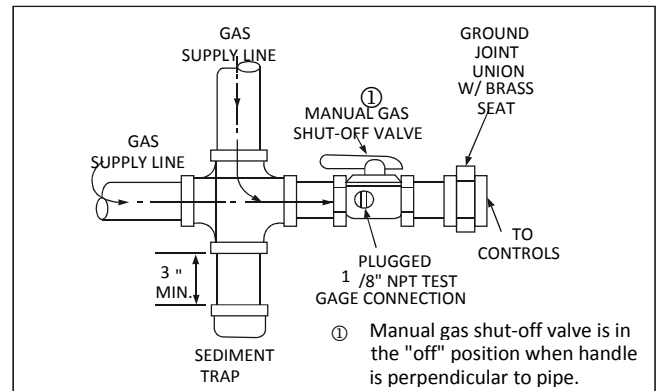

### Manifold Arrangements / Compliance

The standard ETL manifold arrangement is designed to meet ANSI standards. Additional manifold arrangements are available to comply with the requirements of FM (Factory Mutual) or GE GAP 4.3.1 (formerly IRI - Industrial Risk Insurers).

Refer to the piping diagram affixed to the unit access door to determine which manifold arrangement was ordered.

## INSTALLATION / PRIOR TO START-UP / OPERATION

### Electrical Connections

#### WARNING

1. Disconnect power supply before making wiring connections to prevent electrical shock and equipment damage.
2. If equipped with the factory installed disconnect switch option, when the switch is in the "OFF" position, supply power remains energized at the supply power terminal strip and the top of the disconnect switch. When providing service on or near these terminals, building supply power to the unit should be de-energized.
3. All appliances must be wired strictly in accordance with the wiring diagram furnished with the unit. Any wiring that is different from the wiring diagram could result in a hazard to persons and property.
4. Any original factory wiring that requires replacement must be replaced with wiring material having a temperature rating of at least 105°C.

#### CAUTION

Ensure that the supply voltage to the appliance, as indicated on the serial plate, is not 5% less than the rated voltage.

1. Installation of wiring must conform with local building codes, or in the absence of local codes, with the National Electric Code ANSI/NFPA 70 - Latest Edition. Unit must be electrically grounded in conformance to this code. In Canada, wiring must comply with CSA C22.1, Part 1, Electrical Code.

2. Job specific wiring diagrams are furnished with each unit. A permanent laminated diagram is located on the inside of the electric control cabinet door. The unit is supplied with a labeled terminal strip for ease of wiring. Refer to this diagram for all wiring connections.

3. Make sure all multi-voltage components (motors, transformers, etc.) are wired in accordance with the power supply voltage.

4. The power supply to the unit must be protected with a lockable fused or circuit breaker disconnect switch. If a disconnect switch is not supplied with the unit, the field-supplied disconnect must have adequate ampacity and must be installed in accordance with Article 430 of the National Electric Code, ANSI/NFPA 70.

5. The power supply must be within 5% percent of the voltage rating and each phase must be balanced within 2% of each other. If not, advise the utility company.

6. For ease of electrical connections, the unit may include two 10-foot long pre-wired wiring harnesses in flexible conduit. One harness is for the power wiring. The other harness is for the remote panel wiring. The wiring in both harnesses are labeled for ease of field connections. The harnesses can be routed through the base of the unit through the factory installed wiring harness floor chase. Refer to Figure 8.1.

7. If the floor chase is not used and electrical connections are made through the side of the unit, all outdoor electrical connections must be weatherized to prevent moisture from entering the electrical compartment.

8. External electrical connections to be installed include:

- Supply power connection (115, 208, 230, 380, 460, or 575 volts).

- Connection of thermostats, remote monitoring panels, time clocks, or other accessory control devices that may be supplied (115 and/or 24 volts - refer to unit wiring diagram).

- Connection of external electrical interlocks from devices such as fire damper actuator end switches, smoke detectors, exhaust fan interlocks, etc. Electrical interlocks that are to shut the unit down for safety reasons must be connected in the safety limit control circuit to cause the heater to shut down.

FIGURE 8.1 - FACTORY INSTALLED WIRING HARNESSES WITH FLOOR CHASE UNIT BASE

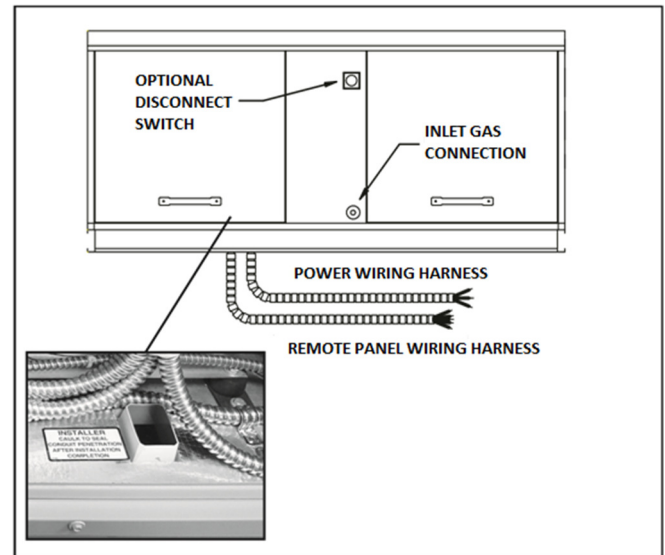

9. If the unit is not factory supplied with an optional timed freeze protection, then a low-temperature limit control must be field supplied and installed in areas where freeze protection is needed in the event of burner shutdown.

10. When complete, seal the opening of the floor chase (see Figure 8.1) so it is air tight.

### Prior To Start-Up / Operation

Each unit is supplied with this Installation and Service Manual, which includes a Field Start-Up Form, starting on page 29. The Field Start-Up Form must be followed and properly filled out by the installer, with one copy kept with the unit.

Before continuing with the start-up and checkout procedure, it is important to familiarize yourself with the controls and features of the unit. Review the following:

- Documents shipped with the unit to determine which options/controls are included.
- Pages 9 through 17 provide photographs, locations, and descriptions for unit features, options, accessories, and controls.

Once a thorough review of these controls and devices has been made, the step-by-step Start-Up Procedure as described on pages 18 through 23 must be performed.



## UNIT FEATURES - CONTROL CABINET

FIGURE 9.1 - FEATURE AND FACTORY MOUNTED OPTION LOCATIONS

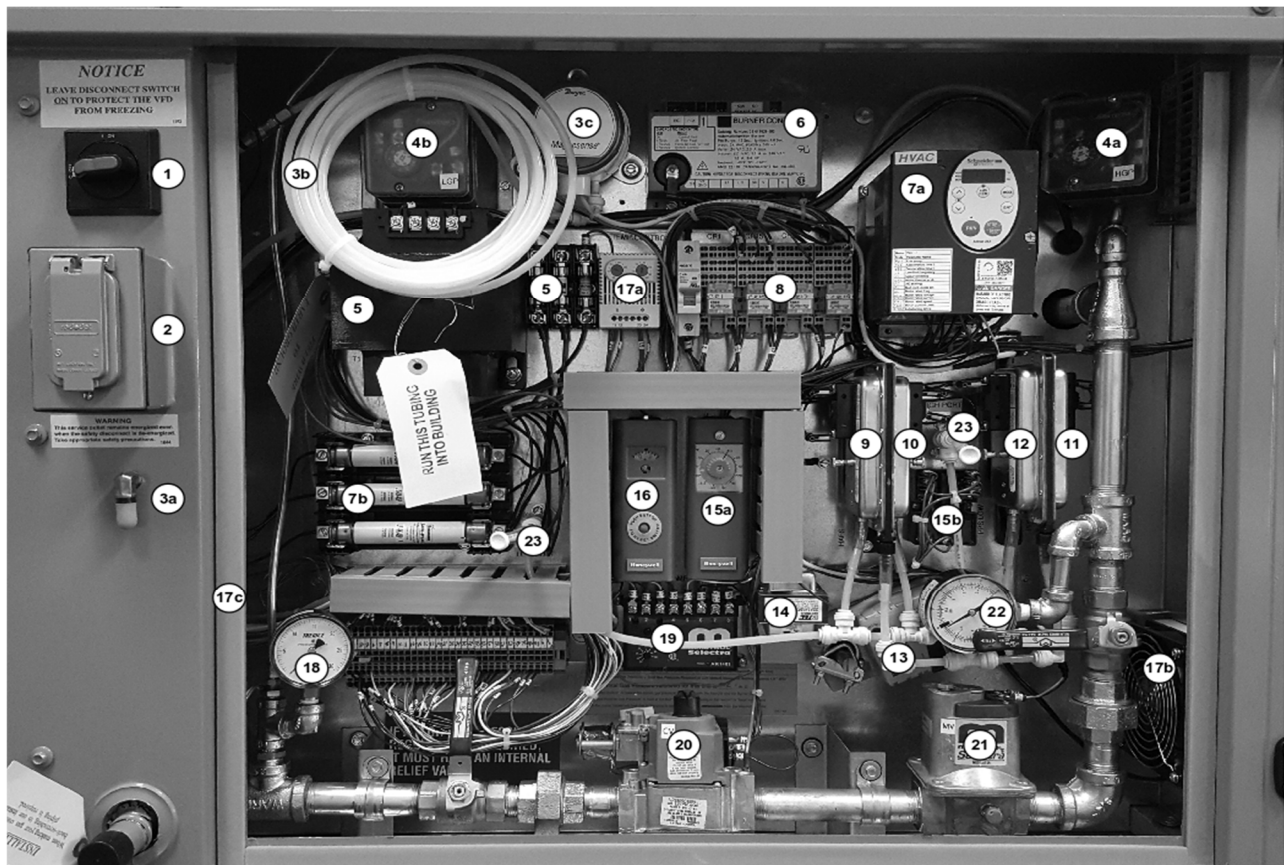

The following refer to Figure 9.1. These items are described in greater detail on the following pages. Note that (S) indicates a Standard feature and (O) indicates an Optional feature.

1. (O) Non-Fused Disconnect Switch
2. (O) GFI Convenience Outlet
3. (O) Space Pressure Control, consisting of (a) Outdoor Pressure Pickup, (b) Pressure Tubing (run indoors), and (c) Differential Pressure Switch
4. (O) Gas Pressure Switches, (a) High, and (b) Low
5. (S) Control Power Transformer and Fuses
6. (S) Flame Safeguard Control
7. (O) (a) Variable Frequency Drive and (b) Fuses
8. (S&O) Control Relays
9. (S) High Air Flow Cutoff Switch
10. (S) Low Air Flow Proving Switch
11. (S) High Pressure Switch for Burner Profile
12. (S) Low Pressure Switch for Burner Profile
13. (S) Burner Profile Damper Actuator
14. (S) 24V Isolation Transformer
15. (O) Timed Freeze Protection, consisting of (a) Low Limit Discharge Temperature Thermostat, and (b) Freeze Protection Timer
16. (S) High Temperature Limit Thermostat
17. (O) Cabinet Heating and Ventilation System, consisting of (a) Thermostat, (b) Cooling Fan, and (c) Heater
18. (O) Inlet Gas Pressure Gauge
19. (S) Temperature Control Amplifier or Signal Conditioner
20. (S) Main Gas Valve
21. (S) Modulating Gas Valve
22. (O) Burner Gas Pressure Gauge
23. (S) Profile Pressure Test Ports (2)

The following details the standard and factory installed options available as shown in Figure 9.1. [(S)=Standard, (O)=Option]

## WARNING

If equipped with the factory installed disconnect switch option, when the switch is in the "OFF" position, supply power remains energized at the supply power terminal strip and the top of the disconnect switch. When providing service on or near these terminals, building supply power to the unit should be de-energized

### 1. (O) Non-Fused or Fused Disconnect Switch

Factory installed on the stationary panel next to the door, the switch provides a convenient method of turning off power to the unit. When in the "OFF" position, power is disconnected to all unit wiring electrically following the switch but remains energized before the switch (See Warning). Available as non-fused or fused.

### 2. (O) GFI Convenience Outlet

Includes a 115V/1ph duplex weatherproof service receptacle mounted on the exterior of the cabinet. Available as either powered by others (shown) or powered by the unit (not shown). When powered by unit, the option includes an additional unit mounted disconnect switch and step-down transformer for supply voltages above 115V.

### 3. (O) Space Pressure Control

This configuration is typically used to maintain a slight positive pressure in the building to reduce infiltration. It is also used to provide variable volume make-up air for buildings that have multiple exhaust loads that cannot be interlocked to one make-up air unit. This option includes the following factory installed items:

- Outdoor Pressure Pickup (or Indoor Pressure Pickup for indoor mounted units)
- Indoor Pressure Pickup with 12' Tubing for routing to space (or Outdoor Pressure Pickup for indoor units)
- Pressure Transmitter

The pressure transmitter monitors the space pressure relative to the outdoor air pressure and adjusts the VFD speed from full rated speed to as low as 35% of rated speed to bring in more or less outside air.

### 4. (O) High and Low Gas Pressure Switches

A. The low gas pressure switch monitors the gas supply pressure ahead of all the gas train components to ensure there is sufficient pressure for proper ignition. If the gas pressure is below the set point of the switch, the flame safeguard controller is disabled and the switch will auto-reset.

B. The high gas pressure switch monitors the gas pressure between the gas manifold components and the burner to ensure the gas pressure has not exceeded the maximum rating. Gas pressures above the maximum rating may damage the gas train components or cause the unit to over-fire. If the gas pressure is above the set point of the switch, the flame safeguard controller is disabled and the switch must be manually reset to allow the unit to function.

### 5. (S) Control Power Transformer and Fuses

All units include a transformer used to reduce the supply voltage to the voltage required for the unit controls.

### 6. (S) Flame Safeguard Control

The flame safeguard control monitors safety devices to determine if the gas ignition sequence should be initiated. Once initiated, the control will also monitor a flame rod flame sensor to verify burner flame. The control includes a pre-purge timer to clear any residual gas in the unit before ignition can be initiated. The ignition type varies by unit capacity as follows:

- Direct Spark (shown in Figure 9.1)
- Interrupted Pilot (see Figure 10.1)

FIGURE 10.1 - FIREYE FLAME SAFEGUARD CONTROL



### 7. (O) Variable Frequency Drive and Fuses

Units with a "V" in the model number (i.e. T2-HVX) are equipped with a factory installed VFD to provide control of air volume through varying the speed of the blower from 100% down to as low as 35%. The VFD can be programmed to provide any one of the following control configurations:

- **Constant Speed (field adjustable):** VFD will operate at full speed but can be adjusted in the field via a manual potentiometer mounted at the remote panel.
- **Two Speed:** VFD will operate at full rated speed or user defined low speed. The remote panel will include a High/Low speed switch for high/low speed changeover.
- **External 4-20 mA or 0-10 Vdc Control Signal:** VFD can be externally controlled from full rated speed down to 35% of rated speed. Unit includes terminals for landing external control wiring.
- **Space Pressure Control:** See #3 for information on this control configuration.

### 8. (S & O) Control Relay

Includes double-pole, double throw (DPDT) contacts for sequence of operation control switching. The function of the relays must be specified at the time of order.

### 9. (S) High Air Flow Cutoff Switch

The switch monitors the pressure drop across the burner to insure the air flow through the burner does not exceed the maximum design velocity. The switch is electrically interlocked with the flame safeguard control (#6).

### 10. (S) Low Air Flow Proving Switch

The switch monitors the pressure drop across the burner to ensure that sufficient air flow exists before allowing the burner to operate. The switch is electrically interlocked with the flame safeguard control (#6).

Items #11 through #13 are part of the Auto-Profiler System that constantly and automatically adjusts a burner profile damper to maintain proper burner air velocity for optimal combustion. The system has a range of operation to allow for correction of airflow changes from filters becoming dirty, changes in airflow when using a VFD, or slight changes in system duct static. It does not eliminate the requirement for proper system balancing at commissioning. The Auto-Profiler System components are as follows (refer to Figures 9.1 and 11.1):

**11. (S) High Burner Profile Pressure Switch**

The switch monitors the pressure drop across the burner and if the pressure is too high (excessive airflow), the burner profile damper motor (#13) is energized to adjust the profile balancing damper to allow more airflow to bypass the burner to reduce the pressure drop (velocity) into the acceptable range.

**12. (S) Low Burner Profile Pressure Switch**

This switch monitors the pressure drop across the burner and if the pressure is too low (reduced airflow), the profile balancing motor (#13) is energized to adjust the profile balancing damper to allow less airflow to bypass the burner to increase the pressure drop (velocity) into the acceptable range.

**13. (S) Profile Bypass Damper Actuator**

The damper actuator is directly coupled to the profile bypass damper and will increase or decrease the opening position based on changes in burner profile velocity as measured by the high and low-profile pressure switches (#11 and #12).

**FIGURE 11.1 - AUTO-PROFILER SYSTEM**

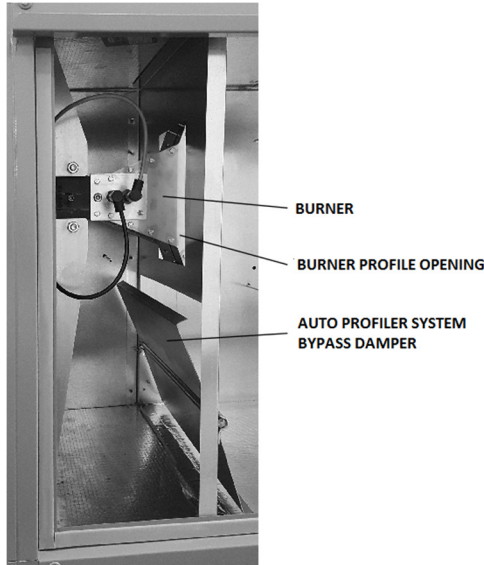

**14. (S) 24v Isolation Transformer**

A 24V to 24V transformer is used to electrically isolate sensitive controls from the rest of the control circuit.

**15. (O) Timed Freeze Protection**

Low limit duct thermostat monitors the discharge air temperature and if below the set point, the unit will shut down to prevent delivery of cold air. Includes the following:

**A. Low limit discharge duct thermostat:** The control is mounted in the control cabinet while the sensor is mounted in the blower cabinet (see Figure 12.1).

**B. Freeze Protection Timer:** The 5-minute timer allows the unit to go through the normal start-up sequence while temporarily bypassing the low limit discharge duct thermostat.

**16. (S) High Temp Limit Thermostat**

The high temperature limit control prevents the burner from firing if excessive heated air temperatures are experienced. The limit control is mounted on the blower housing and is electrically interlocked with the flame safeguard control (#6). The switch requires a manual reset if tripped.

**17. (O) Cabinet Temperature Control**

Cabinet temperature control options are available for units with a factory mounted VFD. In extreme ambient temperatures, the temperature in the cabinet can impact the performance and longevity of the VFD. Includes some or all of the following:

- A. Enclosure Mounted Thermostat: Activates an electric heater and/or cooling fan as needed. Included with either (B) or (C).
- B. Enclosure Cooling Fan: Required for locations where the unit is in ambient temperatures 85°F and higher.
- C. Enclosure Heater: Required for locations where the unit is in ambient temperatures below 0°F. For ambient temperatures above 0°F, the heater is recommended but not required.

**18. (O) Inlet Gas Pressure Gauge**

The inlet gas pressure gauge option provides a method to easily determine if the gas pressure entering the unit is within the range required, without having to connect a manometer.

**19. (S) Temperature Control Amplifier or Signal Conditioner**

The amplifier converts the temperature control signal from the discharge air temperature sensor (and room temperature sensor if the Maxitrol 44 system is used) or external signal for Maxitrol SC25 systems and modulates the gas valve (#21) to maintain the air temperature set point.

**20. (S) Main Gas Valve**

All units are supplied with redundant automatic main gas shut-off valves to control gas flow to the modulating gas valve (#21). These valves may be a combination gas valve as shown, which have two valve seats in one valve body or two separate gas valves on higher MBH capacity models.

**21. (S) Modulating Gas Valve**

The modulating gas valve is controlled by the temperature control amplifier or signal conditioner (#19) to vary the flow of gas to the burner.

**22. (O) Burner Gas Pressure Gauge**

The burner gas pressure gauge verifies the gas pressure so it matches the manifold pressure listed on the serial plate.

**23. (S) Profile Pressure Test Ports (2)**

Used during startup to easily connect a manometer to measure profile pressure drop during unit balancing.

FIGURE 12.1 - FEATURES AND OPTION LOCATIONS - BLOWER CABINET

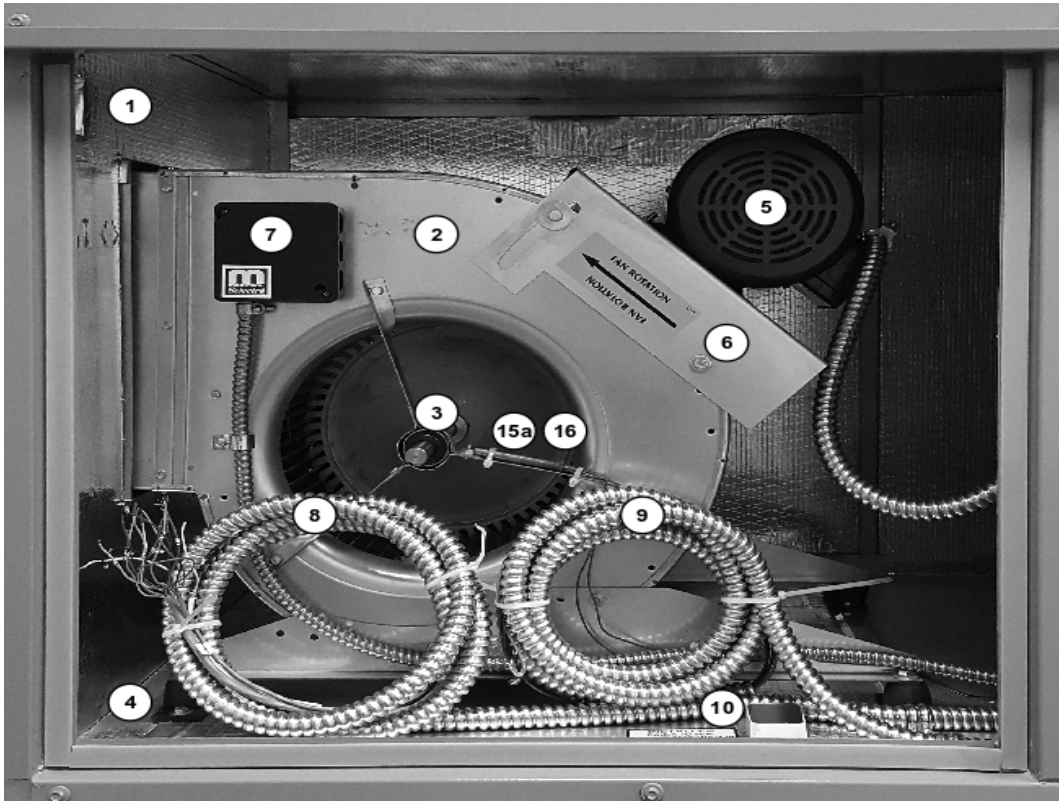

**4. (S) Blower/Motor Vibration Isolation**

All units include neoprene blower/motor assembly vibration isolation as standard. For more robust vibration isolation, the following are options available:

- (O) Rubber-In-Shear isolation on all sizes.
- (O) Spring isolation on all except T1 Models.

**5. (S) Supply Air Blower Motor**

**6. (S) Adjustable Motor Base**

Provides adjustability of the motor position to ensure correct drive belt tension.

**7. (S) Maxitrol Discharge Air Sensor**

Standard for Maxitrol 14 and 44 gas control systems, the sensor

provides functions specific to the gas control type.

•**Maxitrol 14:** The sensor measures the discharge air temperature and provides feedback to the Maxitrol 14 controller to maintain the discharge air temperature set point by modulating the gas valve.

•**Maxitrol 44:** The sensor measures the discharge air temperature and provides feedback to the Maxitrol 44 controller to limit the modulation range so that space temperatures do not fall outside the allowed range.

**8. (S) Wiring Harness – Control Wiring**

The 10-foot long pre-wired harness in flexible conduit allows for quick connection to the remote panel mounted in the space. The wires are numbered to correspond to a numbered terminal strip within the remote panel.

**9. (S) Wiring Harness – Power Wiring**

The 10-foot long pre-wired harness in flexible conduit allows for quick connection to the supply power for the unit.

**10. (S) Floor Mounted Wiring Chase**

Provides a pathway through the floor of the unit to route the Control and Power Wiring Harnesses to the space without needing to drill holes.

**11. (O) Timed Freeze Protection**

A low limit duct thermostat monitors the discharge air temperature and if below the set point, the unit will shut down to prevent delivery of cold air.

**12. (S) High Temp Limit Thermostat**

The high temperature limit control prevents the burner from firing if excessive heated air temperatures are experienced. The limit control is mounted on the blower housing and is electrically interlocked with the flame safeguard control (#6). The switch requires a manual reset if tripped.

**UNIT FEATURES - BLOWER CABINET**

The following refer to Figure 12.1. These items are described in greater detail on this page. Note that (S) indicates a Standard feature and (O) indicates an Optional feature.

**1. (S) Flame Observation Port**

Provides visible indication of the flame and flame quality while the unit is operating with the casing closed.

**2. (S) DWDI Blower Wheel**

Double Width, Double Inlet blower wheel.

**3. (S) Blower Bearing Assembly**

Most blower assemblies are available with either spider bearings or pillow block bearings as follows:

•**Spider Bearings (shown):** Standard for T1 through T4 Models, not available on T5 Models. Spider bearings include blower mounted bearing brackets with ball bearings. Spider bearings are designed for use in lower torque applications as typical on the smaller blowers. Spider bearings are permanently lubricated.

•**Pillow Block Bearings:** Optional for T1 through T4 Models, standard on T5 Models. This option includes two heavy duty pillow block bearings rigidly fastened to two blower support channels. Pillow block bearings are available for all applications, but are required for high torque applications typical for larger blowers. Pillow block bearings require periodic lubrication as part of normal maintenance.

(O) **Extended Bearing Grease Lines (not shown):** Extended grease lines are an available option for pillow block bearings. They include factory installed grease lines extending from the blower bearings to Zerk fittings on the outside of the unit cabinet.

## UNIT FEATURES - OPTIONAL SIDE ACCESS FILTER SECTION

FIGURE 13.1 - FACTORY MOUNTED OPTIONS-SIDE ACCESS FILTER SECTION

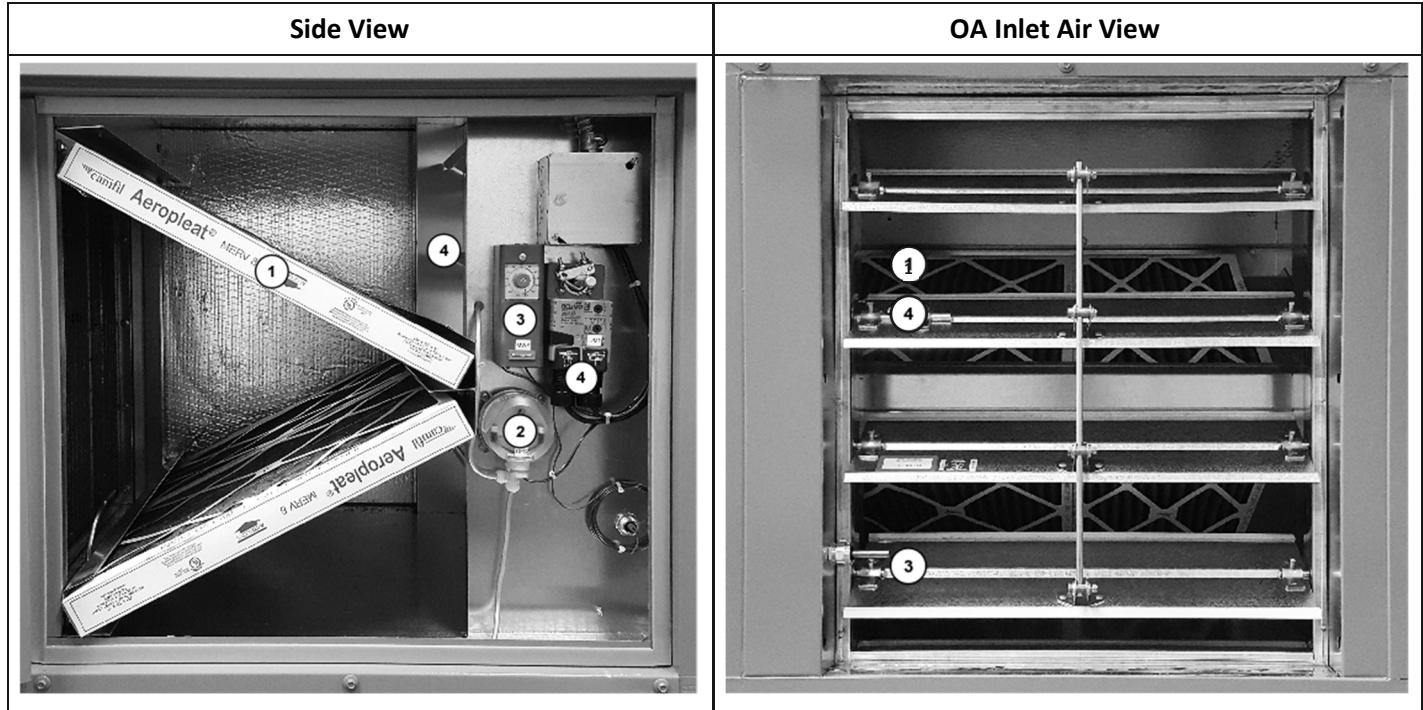

The following refer to Figure 13.1. These items are described in greater detail on this page. Note that (S) indicates a Standard feature and (O) indicates an Optional feature.

### 1. (O) Side Access Filter Section

The side access filter section is optional and is used to filter outside air drawn through the unit. Available either painted or unpainted to match the unit. The section is available with several filter configurations:

- 2" permanent, aluminum mesh washable filters
- 2" disposable MERV 8 pleated filters (shown)
- 2" disposable MERV 13 pleated filters

### 2. (O) Dirty Filter Switch

A differential pressure switch that measures the pressure drop across the filter media. When the pressure drop exceeds the setpoint, the switch closes to indicate the filters need to be serviced.

### 3. (O) Mild OA Temperature Thermostat

Used to automatically shut off the burner when the OA inlet air temperature reaches the desired set point to prevent the burner from running at low fire during mild outdoor air temperature conditions.

### 4. (O) Inlet Damper

Used to prevent conditioned building air from exiting the building through the unit when the unit is not operating. Both standard and low leak dampers are available. The inlet damper option includes a 2-position damper actuator that is available as either power or spring closed. The damper actuator includes an end switch to prevent unit operation unless the dampers are open. Discharge dampers are also available. Please see Accessories section for additional details.

## OPTIONAL EVAPORATIVE COOLER

### Evaporative Cooling Module

Outdoor units can be provided with a factory installed evaporative cooling module. The casing interior is unpainted, 304 grade stainless steel to provide outstanding corrosion resistance.

The evaporative cooler is a simple, non-recirculating design that reduces up-front costs and maintenance. Benefits of the non-recirculating design are the following:

- A recirculation pump and float switch are not required.
- No sump required, reducing maintenance and water usage to reduce microbial growth that can occur from poorly maintained recirculating systems.
- There is a continuous wash-down of the media with fresh water to keep it flushed, increasing the lifespan of the media and reducing maintenance.
- There is reduced risk of freeze damage that can be seen with recirculating units with a sump.

FIGURE 14.1 - EVAPORATIVE COOLER - SIDE ACCESS

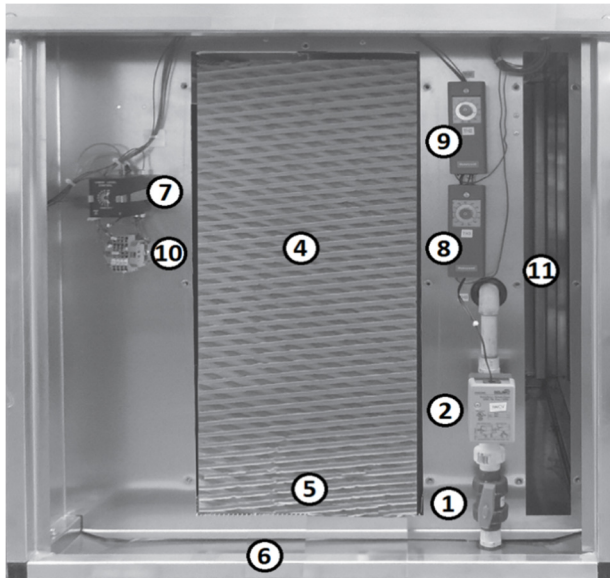
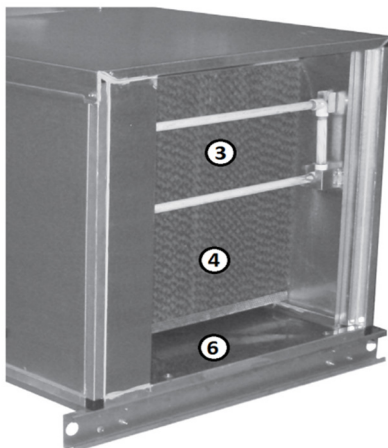

FIGURE 14.2 - EVAPORATIVE COOLER - INLET AIR OPENING



The following details the standard and factory installed options available as shown in Figures 14.1 and 14.2. [(S)=Standard, (O)=Option]

#### 1. (S) Water Supply Connection

Includes a hand shut-off valve as standard. An accessory Water Supply Valve Kit (not pictured) is available that provides the following:

- Supply water valve (2-way)
- Supply line drain valve (2-way)
- Freeze thermostat

When ordered, this kit is shipped loose for field installation in a frost-free environment (typically below the roof line). Refer to the Installation & Service Manual for additional details.

#### 2. (S) Internal Water Control Valve (IWCV)

Valve controlled by the Liquid Level Controller (LLC) to allow water flow to the water distribution piping when wetted media is required.

#### 3. (S) PVC Water Distribution Piping

The piping includes spray nozzles that uniformly distribute water on the face of the media.

#### 4. (S) Evaporative Cooling Media

The standard media is Munters (6" or 12") CELdek® Cellulose evaporative cooling media.

For applications requiring UL 900, Class 2 fire rating and compliance with NFPA codes, optional Munters 12" GLASdek® Fiberglass media is offered.

The media is accessible from the side access opening (media access cover removed for display purposes).

#### 5. (S) Overflow Water Sensor (OWS) (not shown)

On a call for cooling, the Liquid Level Controller (#7) monitors the overflow water sensor, located at the bottom of the media, and opens the IWCV (#2) to provide water flow to wet the media.

When the OWS senses moisture it is indication the media is saturated and the LLC turns off the IWCV (#2) to conserve water.

#### 6. (S) 304 Stainless Steel Casing and Pitched Drain Pan

Stainless steel offers outstanding corrosion resistance. Includes shipped loose adjustable leveling legs for support (not shown).

#### 7. (S) Liquid Level Controller (LLC)

Controller that monitors the OWS (#5) to determine if the IWCV (#2) should be open or closed. Optimizes water consumption to avoid excessive water usage.

#### 8. (S) Outdoor Air Thermostat

Measures the outside air temperature and if the temperature is above the set point, a call for cooling is initiated to the LLC (#7).

#### 9. (O) Freeze Thermostat

Measures the outside air temperature and if the temperature is below the set point, prevents the evaporative cooler supply water valve from being energized. This is part of the Water Supply Valve Kit discussed in #1.

**10. (S) Auxiliary Wiring Terminal Strip**

The auxiliary wiring terminal strip is used for factory wiring between the evaporative cooler controls and the main unit terminal strip.

**11. (O) 2" Permanent Aluminum Mesh Pre-Filters**

Optional pre-filters (not shown) can be added in the empty slot indicated by #11. The filters are accessible from the side access opening (filter access cover removed for display purposes).

**Also available as a field installed accessory (not shown) is an inlet hood that can be with or without 2" thick permanent aluminum mesh filters**

**Evaporative Cooling Performance Example**

Evaporative cooling works by placing a wet media in the entering air stream of the cooling unit. As the air passes through the media, sensible heat from the air is transferred to the water in the cooling media, causing the water to evaporate. Because the sensible heat from the air is simply transferred to the water, and both the water vapor and cooled air remain in the system, there is no net energy change in the system. However, the dry bulb temperature of the air has been lowered and provides cooling for the space.

The temperature of the cooling air will be dependent on three criteria. These criteria are:

- The design dry bulb temperature
- The design wet bulb temperature
- The percent effectiveness of the cooling media which is obtained from the media performance curve shown in Figure 15.1. The effectiveness is based on the velocity, which can be calculated by dividing the airflow in CFM by the face area of the cooling media as shown in Table 15.1.

**TABLE 15.1 - EVAPORATIVE COOLING PERFORMANCE DATA**

Unit Model	Evap Cooler Model	Max CFM	Media Area
T1	EVN1	2,200	4.00 ft <sup>2</sup>
T2	EVN2	3,500	5.78 ft <sup>2</sup>
T3	EVN3	5,000	9.17 ft <sup>2</sup>
	EVN4	7,500	13.33 ft <sup>2</sup>
T4	EVN4	7,500	13.33 ft <sup>2</sup>
	EVN5	9,500	20.00 ft <sup>2</sup>
T5	EVN5	11,000	20.00 ft <sup>2</sup>
	EVN6	14,000	25.00 ft <sup>2</sup>

**FIGURE 15.1 - EVAPORATIVE COOLER EFFECTIVENESS CURVE**

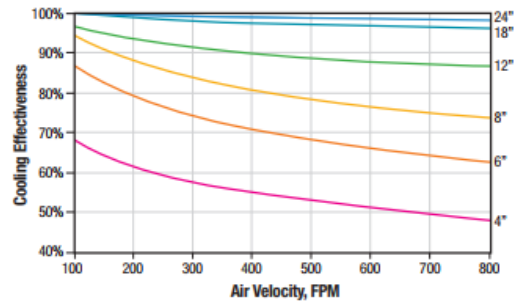

**Example:** Determine the final dry bulb temperature for a unit Model T4, rated airflow of 8,000 CFM, installed in Phoenix, Arizona. Also, determine the approximate gallons per hour evaporated and the apparent cooling capacity of the evaporative cooler. The following are the steps to determine the solution to the example problem above:

1. The 1.0% ASHRAE design conditions are 110°F Db / 70°F Wb.
2. There are two options for the Model T4 unit shown in Table 15.1, however only one can be operated at 8,000 CFM, the EVN5 Evap Cooler Model. The Media Area is 20.0 ft<sup>2</sup>. The air velocity is then calculated as follows:

**FPM = CFM ÷ Media Face Area = 8,000 CFM ÷ 20 ft<sup>2</sup> = 400 FPM**

3. The media effectiveness is determined in Figure 15.1 (Y-axis) by finding where the effectiveness curve intersects 400 FPM velocity on the X-axis. In this example, the effectiveness is approximately 90%.

4. Determine final dry bulb air temperature of conditioned air by using the following formula:

**LAT = EAT Db - (% Eff. × (EAT Db - EAT Wb))**

**LAT = 110°F - (0.90 × (110°F - 70°F)) = 74°F Db**

5. The gallons per hour (GPH) evaporated is calculated as follows:

**GPH = (1.2 × CFM × (EAT Db - LAT Db)) ÷ 10,000**

**GPH = (1.2 × 8,000 × (110°F - 74°F)) ÷ 10,000 = 34.6 GPH**

6. The cooling capacity, Q, of the unit is defined as the apparent cooling capacity because it is dependent on a specific set of temperature conditions. As these conditions change, so will the apparent cooling capacity. The formula is as follows:

**Q = 1.08 × (EAT Db - LAT Db) × CFM**

**Q = 1.08 × (110°F - 74°F) × 8,000 CFM = 311,040 Btu/Hr**

**Definition of Terms:**

**EAT** = Entering Air Temperature

**LAT** = Leaving Air Temperature

**Db** = Dry Bulb

**Wb** = Wet Bulb

**% Eff.** = Percent Effectiveness

**Q** = Apparent Cooling Capacity

# ACCESSORIES - FIELD INSTALLED - REMOTE PANEL

FIGURE 16.1 - TYPICAL REMOTE MONITORING (MAXITROL 14 SHOWN)

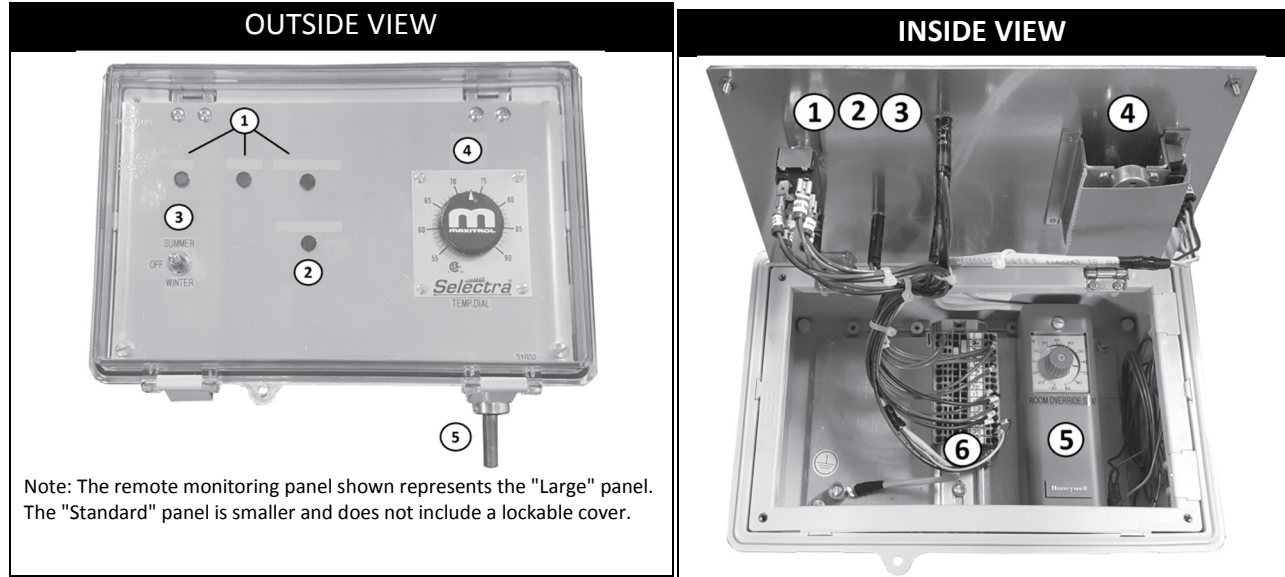

Note: The remote monitoring panel shown represents the "Large" panel. The "Standard" panel is smaller and does not include a lockable cover.

The following refer to Figure 16.1. These items are described in greater detail on this page. Note that (S) indicates a Standard feature and (O) indicates an Optional feature.

## Remote Monitoring Panel

The remote monitoring panel is used to monitor/control the operation of the make-up air unit for all gas control types except the Honeywell SPYDER (DDC) system.

Available panels are:

- **Standard Panel:** 4-3/8" H x 7-3/4" W x 2-3/8" D, rated NEMA 5 (satisfies NEMA 1, 2, and 5 requirements)
- **Large Panel:** 7-1/2" H x 10-1/2" W x 5-5/8" D, rated NEMA 4x (satisfies NEMA 1, 4, and 4x requirements), includes a clear polycarbonate lockable cover (Figure 16.1)

Remote monitoring panel features include:

### 1. (S) Standard LEDs

The standard lights included with each panel are:

- **Fan:** Indicates if the fan is operating.
- **Burner:** Indicates if the burner is on.
- **Burner Lockout:** Indicates if there is a flame failure. This option is resulting in the burner being locked out of operation.

### 2. (O) Dirty Filters LED

The optional light indicates if the filters need to be cleaned or replaced. Requires a Dirty Filter switch (#2 on page 13).

### 3. (S) Standard Switch

All panels include a Summer/Off/Winter switch that can be Summer (fan without heat), Winter (fan with heat), and Off (unit in standby).

### 3. (O) Optional Switch(es) (not shown)

Depending on the unit configuration, the remote panel may operation have additional switch(es). Other possible switches are:

- **High/Low:** Speed switch for units with 2-speed

### 4. (S) Temperature Control

Depending on the unit configuration, the remote panel may have one of the following temperature controls:

- **Discharge Temp Setpoint Dial:** Maxitrol 14 units
- **Modulating Room Thermostat:** Maxitrol 44 units
- **None:** Maxitrol SC25 units

### 5. (O) Room Override Thermostat

Used only with Maxitrol 14 gas controls, the room thermostat automatically overrides the discharge air temperature setting to provide warmer discharge air until the room override thermostat is satisfied.

### 6. (S) Wiring Terminal Strip

The wiring terminal strip provides an easy means of connecting the flexible conduit wiring harness from the unit to the remote panel. The wiring harness wires are numbered, as are the corresponding terminals on the terminal strip.

For information on units equipped with the Honeywell SPYDER Controller and LCD Interface module, see the following page.



# ACCESSORIES - FIELD INSTALLED - REMOTE PANEL / OTHER

FIGURE 17.1 - HONEYWELL SPYDER CONTROLLER INTERFACE

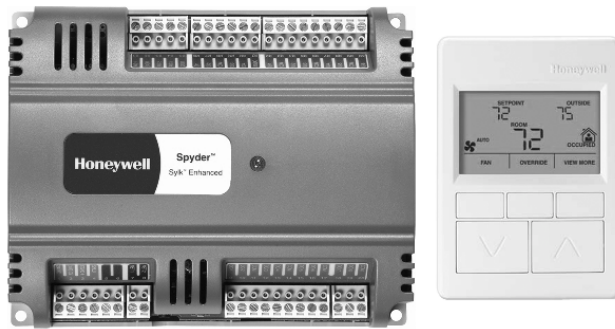

## Honeywell SPYDER LCD Remote User Interface (TR75)

Available only on the Honeywell SPYDER controlled units, the TR75 remote user interface provides access to all information needed to control, maintain, and troubleshoot the unit. A few of the key features of this system include:

- Replaces the remote panel shown on page 16.
- A simple 2-wire terminal connection from the unit provides power and communications to the remote.
- Alarm codes indicate faults that can lock out the burner or unit, including mechanical and/or electrical issues.
- The network interface capability allows easy and cost-effective connection to either a BACnet MS/TP or LonWorks building management system (BMS).
- All capabilities available at the remote are available over the network. Set point changes at the remote are reflected in the network points and vice-versa.
- No custom programming is required, only the configuration of network parameters.
- Electrical components and associated cost are reduced by integrating them into the controller programming.
- On loss of power all programming and set points are retained in flash memory for up to ten years.
- Sensors and outputs are always connected to the same controller terminals regardless of unit type, simplifying startup, maintenance, and service.

## Timeclock

A timeclock can be used for occupancy control to automatically turn the unit on during scheduled occupied periods and off during unoccupied periods. Two timeclocks are offered:

- **Programmable:** The programmable time clock is an electronic 7-day, 24-hour digital display electronic timer with battery backup. In addition to automatic on/off control, the timeclock can be programmed for other time-specific functions throughout the day and with different programs for each day of the week.
- **Mechanical:** The mechanical time clock does not allow the different sequences for each day of the week.

## Smoke Detector

Low profile duct style photoelectronic smoke detector designed to detect the presence of smoke in the duct. Once the smoke is sensed, the smoke detector will de-energize the unit.

## Inlet Hood

Used to minimize the entry of moisture into the fresh air opening of the unit and includes mesh bird screen. Available either painted or unpainted and with or without 2" permanent aluminum mesh washable filters. Inlet hood is shipped knocked down for field assembly.

## Discharge Damper

Used to prevent conditioned building air from exiting the building through the unit when the unit is not operating. Both standard and low leak dampers are available. The discharge damper includes a 2-position damper actuator that is available as either power or spring closed. The damper actuator includes an end switch to prevent unit operation unless the dampers are open. The damper is fully assembled and the housings are always painted. The discharge damper ships as follows:

- **End Discharge Units:** Factory installed on the unit.
- **Down Discharge Units:** Ships loose for field installation.
- **Up Discharge Units:** Factory installed on the unit.

Factory installed inlet dampers are available. Please page 13 for additional details.

## Discharge Diffusers (3-Way or 4-Way)

The adjustable louvers provide either 3-way or 4-way control of discharge airflow direction. The diffuser is factory assembled but shipped loose for field installation. Discharge diffusers are always painted.

## Roof Curb (Outdoor Units Only)

The roof curb is constructed of galvanized steel and is designed to support the unit and side access filter section (if equipped). The curb does not extend to the optional evaporative cooler (evaporative cooler is supplied with support legs). The curb is knocked down for field assembly and may include 1" x 4" nailer strips and curb-to-unit gasket material. Available with or without fiberglass or foil-face insulation. Roof curb is 20" tall.

## Vibration Feet (Slab Mounted Units Only)

Used to provide vibration isolation, vibration feet consist of rubber-in-shear double deflection isolators with support mounting.

## Vibration Hangers (Suspended Units Only)

Used to provide vibration isolation, vibration hangers consist of rubber-in-shear double deflection hanging isolators.

# START-UP PROCEDURE

## WARNING

1. If equipped with a factory installed disconnect switch, when the switch is in the "OFF" position, supply power remains energized at the supply power terminal strip and the top of the disconnect switch. When providing field service on or near these terminals, building supply power to the unit should be de-energized.
2. Proper air velocity over the burner is critical. If the velocity is not within the unit specifications, the unit will not operate efficiently, may have nuisance shutdowns, and may produce excessive carbon monoxide (CO) or other gases.

## CAUTION

1. Do not operate unit with a gas input rate greater than that shown on the unit's rating plate.
2. Purging of air from gas supply lines should be performed as described in ANSI Z223.1 - latest edition "National Fuel Gas Code", or in Canada in CAN/CGA-B149 codes.

## IMPORTANT

Start-up and adjustment procedures should be performed by a qualified service technician.

### Before Performing the Start-Up

Before performing the start-up, review "UNIT INSTALLATION" procedures in this manual. To properly perform the start-up, the following instruments are required.

- Volt Meter (25-600 VAC)
- Amp Meter (0-100 Amps)
- Micro-Amp Meter (0-20 mA)
- Ohm Meter
- Gas Pressure Gauge (range dependent on inlet pressure to unit)
- Slack Tube Manometer, or 0-30" wc Pressure Gauge
- Inclined Manometer (0-5" wc)
- Hand Held Tachometer (contact, reflective, or strobe type)

### Pre-Start-Up Inspection

Although this unit has been assembled and tested at the factory, the following pre-operational procedures must be performed to assure the unit is ready for operation.

1. Before proceeding, turn off all power to the unit. Turn all manual hand gas valves to the closed position.
  - Remove all shipping straps, braces and tie downs.
  - Perform a visual inspection of the unit to make sure no damage has occurred during shipment or installation.
  - Check burner to insure it is secure.
  - Check blower and motor alignment, as well as belt tension. For adjustments, refer to section "Blower/ Motor Adjustment" in this manual.
  - Check fan bearings for alignment and tightness. Check bearing to shaft set screws for tightness.
  - Check all electrical connections for tightness.
  - Check to ensure there are no obstructions to the inlet air supply or the discharge air supply.
  - Check fan bearings for proper lubrication. If the unit has been supplied with spider bearings (standard on Models T1-T4), the bearings are permanently lubricated and do not require additional lubrication.

- Check to make sure that air filters are in place, and installed properly according to direction of air flow indicated on the side of the filters.
  - Check gas piping for leaks using a soap/water solution.
2. After these preliminary checks have been made, the unit can be prepared for start-up.

### Performing the Start-Up

After the unit has been installed and the preliminary checks have been made from the previous section, the following start-up can be performed.

1. Turn off all power to the unit. Turn all hand gas valves to the closed position.
  2. Set the optional Summer/Off/Winter switch on the remote control panel to the "Off" position, and set all thermostats to their lowest settings.
  3. Make sure all service doors are installed and/or closed.
  4. With the Summer/Off/Winter switch still in the "Off" position, turn on the electrical supply to the unit.
  5. Move the optional Summer/Off/Winter switch to the "Summer" position (to activate the unit with heat disabled). The inlet and/or discharge outside air damper (if supplied) should open. When in the full open position, the damper motor end switch should close and allow the blower motor to operate.
  6. Check to make sure that the inlet and/or discharge damper (if supplied) opens properly without binding or obstruction.
  7. Check the blower for proper rotation per the airflow arrow on the blower.
  8. Check the motor speed (RPM). For units equipped with a VFD, check motor speed at both high and low speeds.
  9. Check the blower speed (RPM). For units equipped with a VFD, check blower speed at both high and low speeds.
  10. Check the motor voltage. For units equipped with a VFD, check the voltage at high speed. For three phase systems check to make sure the voltage on all 3 legs vary less than 2%.
  11. Check the motor Amp draw to be sure it does not exceed the motor nameplate FLA rating. For units equipped with a VFD, check the Amp draw at high speed. If the motor Amps are too high, it could be a result of the system static pressure being lower than designed, resulting in excessive airflow. Excessive airflow can cause the fan motor protection to trip on overload, can result in decreased air temperature rise, may not allow the burner to fire because of an open high airflow cutout switch, and/or can consume excessive energy. Air volume measurement and adjustment will be necessary.
  12. Measure the unit air volume being delivered and compare to the rated air volume on the unit serial plate. The most accurate way to measure the air volume is by using a pitot traverse method downstream of the blower. Other methods can be used but should be proven and accurate. If the measured air volume does not match, first correct any ductwork or duct termination design issues that may be creating external static pressure differences from design.
- If further correction is required, adjust the fan RPM by adjusting the sheave on the motor as described in the "Blower/Motor Adjustment" section in this manual.



c. If the outdoor air temperature is below 60°F, fire the main burner to achieve a discharge air temperature of approximately 70°F. If the burner does not fire under these conditions, refer to the Service and Troubleshooting section of this manual for additional guidance. If the outdoor temperature is 60°F or greater, do not fire the main burner.

d. Read the pressure differential reading on the burner pressure gauge or manometer. The actual installed pressure differential reading must be 0.55" wc +/- 0.05" wc, or 0.50" wc to 0.60" wc.

e. If the differential pressure is out of range, adjust the fan RPM by adjusting the motor sheave as described in the "Blower/Motor Adjustment" section on page 21. If the required differential cannot be achieved through blower speed adjustments, contact the factory for additional guidance.

f. When the correct burner velocity pressure differential is verified, turn the unit off and open the main disconnect switch. Remove the manometer and replace the tubing plugs in the "High Port" and "Low Port" test ports.

17. The high fire manifold (burner) pressure must be checked to ensure it matches the pressure shown on the unit serial plate. Over-firing from high pressure can result in poor combustion and undesirable levels of combustion byproducts being introduced to the heated space. The procedure is outlined in the following steps. If the unit is equipped with a VFD, this procedure must be performed at HIGH speed.

a. With the unit off, close the main gas manual hand valve. If not equipped with a burner gas pressure gauge, remove the 1/8" pipe plug test port at the burner and attach a water manometer or "U" tube that is at least 12" high. See piping diagram furnished with the unit for pressure tap locations.

b. Start the unit and record the burner suction pressure present at the test port and record the negative number. Next, open the gas valve and allow the burner to ignite (resetting the burner lockout if necessary). Observe the flame during the 10 second at low fire start to make sure it lights across the entire length of the burner and is stable with a clean blue flame.

c. Add the high fire pressure listed on the rating plate to the negative burner suction pressure recorded above. The resulting sum is the actual measured gas pressure required for high fire in the next step.

d. Initiate a short (10-second) period of high fire. High fire can be achieved by one of the following for methods depending on the unit temperature control:

- **Discharge Temp Control:** High fire is achieved by removing wire 29 from terminal 4 on the Maxitrol amplifier.
- **Space Temperature Control:** High fire is achieved by removing wire 24 from terminal 4 and wire 28 from terminal 3 on the Maxitrol amplifier.
- **Signal Conditioner:** High fire is achieved by forcing the control system (by others) to output a full modulation signal (10 Vdc or 20 mA) to the Maxitrol signal conditioner.
- **Honeywell Spyder Control:** High fire is achieved by depressing the HF-Test button located in the electrical wire channel cover near the local alarm light. Once the

button is pressed once, a 10-second period of high fire begins.

If the actual measured pressure is within (+/-) 0.50" wc of the calculated burner pressure above, adjust the gas valve regulator until the measured pressure matches the calculated pressure.

If the actual measured pressure is greater than 0.50" wc from the calculated burner pressure above, check the inlet gas pressure to the unit. Adjust the main gas valve regulator to the correct inlet pressure within the range indicated on the unit rating plate. Once corrected, repeat step #17 to measure the burner pressure.

e. With the high fire manifold pressure set to match the setting on the unit serial plate, observe the flame while in high fire. The flame should be stable and burning clean. The flame should be predominantly blue, although a slight orange tip may be present and is acceptable.

f. After the high fire pressure is correctly set, check the low fire burner flame. Install the wires removed in "d" above. Low fire can be achieved by one of the following methods depending on the unit temperature control:

- **Discharge Temp Control:** Low fire is achieved by removing CR12 or CR15 from its relay base.
- **Space Temperature Control:** Low fire is achieved by removing CR12 or CR15 from its relay base.
- **Signal Conditioner:** Low fire is achieved by forcing the control system (by others) to output the minimum modulation signal (4 Vdc or 0 mA) to the Maxitrol signal conditioner.
- **Honeywell Spyder Control:** Low fire is achieved by removing CR12 or CR15 from its relay base. The flame should still burn clean and stable during low fire. The flame should be 1-2" long. If necessary, adjust the low fire gas pressure on the Maxitrol modulating control valve so the unit operates correctly as described.

g. Recycle the ignition sequence to make sure the burner lights smoothly and the flame is present across the entire length of the burner.

18. With the unit off, close the main gas manual hand valve. If applicable, remove the "U" tube manometer and replace the 1/8" pipe plug test port at the burner.

19. Test the gas seal of the safety shut off valve(s) with the following steps:

a. While the unit is off, close the main gas hand valve and attach a pressure gauge to the downstream side of the last safety shut off valve (SSOV) closest to burner. For units with no pilot line, there is only the one valve (the combination gas valve). For units with a pilot line, there are redundant series piped solenoid valves.

b. Open the main gas hand valve and following the startup procedure described in this manual, turn the unit on and allow the burner to go to main flame.

c. Shut the unit off and let the pressure drop to zero.

d. Close the manual gas hand valve closest to the burner and wait 5 minutes. The main gas manual hand valve should remain open.

e. There should be no changes in pressure. If the pressure increases, the combination or second SSOV needs to be replaced.

f. For units with no pilot line, skip to step #19k. For units with a pilot line, close the main gas hand valve and remove the test plug

located between the two SSOV's and let the pressure to drop to 0 (zero).

g. Move the pressure gauge to the test port between the two SSOV's and replace the plug in the test port downstream of the second SSOV.

h. Open the main gas manual hand valve and wait 5 minutes. The unit should not be operating at this time.

i. There should be no changes in pressure. If the pressure increases, the first SSOV needs to be replaced.

j. Close the main gas manual hand valve and remove the pressure gauge and plug the test port.

k. Open the main gas manual hand valve.

### Verify the Auto-Profiler System Operation

The Auto-Profiler system constantly and automatically adjusts a burner profile bypass damper to maintain proper burner air velocity for optimal combustion. The system has a range of operation to allow for correction of airflow changes from filters becoming dirty, changes in airflow when using a VFD, or slight changes in system duct static. It does not eliminate the requirement for proper system balancing at commissioning. The Auto-Profiler system normally needs no adjustment or set-up; however, the operation should be verified using any or all of the following examples. Note that any unit door that opens to the airstream should be closed. The control cabinet door can be open to observe the rotation of the damper actuator (#13 in Figure 9.1 of "CONTROL CABINET"):

1. If the unit has a side access filter section:

- Remove/open the access door. This will reduce the total static pressure, increasing airflow, and the actuator should turn the damper rod counter-clockwise to open the damper.
- Replace/close the access door. This will increase the total static pressure, decreasing airflow, and the actuator should turn the damper rod clockwise to close the damper.

2. If near the inlet of the unit:

- Place a partial restriction at the unit inlet (a sheet of cardboard works well). This will increase the total static pressure, decreasing airflow, and the Auto-Profiler actuator should turn the damper rod clockwise to close the damper.
- Remove the restriction at the inlet. This will decrease the total static pressure, increasing airflow, and the Auto-Profiler actuator should turn the damper rod counter-clockwise to open the damper.

3. If the unit is equipped with a VFD:

- Reduce the blower speed using the VFD. This will reduce airflow and the Auto-Profiler actuator should turn the damper rod clockwise to close the damper.
- Increase the blower speed using the VFD. This will increase airflow and the Auto-Profiler actuator should turn the damper rod counter-clockwise to open the damper.

4. If the Auto-Profiler actuator does not control the damper during these verification tests, check the following:

- Loosen the Auto-Profiler actuator from the damper rod and verify that the damper can be opened and closed freely without binding or resistance. When retightening the actuator to the damper rod, position of the damper is not important, as the Auto-Profiler system should automatically adjust the position during normal operation.

- Check the wiring to pressure switches and the actuator to be sure all connections are tight and wired correctly.

- Check the tubing that connects the pressure switches to the profile pressure pickup tubes to ensure all tubes are connected, there are no kinks in the tubing, and the tube plugs for the test ports are securely installed.

- If these do not solve the problem, contact the factory at 800-804-4000 or via email at sales@hoodmart.com.

### Blower / Motor Adjustment

Units are supplied with an adjustable drive sheave on the motor and an adjustable motor mounting base. Adjustments to the motor sheave should only be done if the unit delivered air volume does not match the design volume shown on the unit serial plate. If the measured air volume does not match, adjust the blower speed by adjusting the sheave on the motor (refer to Figure 21.1) as follows:

1. Loosen motor base and take belt(s) off of the motor sheave.
2. Loosen the set screw(s) on the outer side of the adjustable motor sheave.
3. To increase blower speed, turn the outer side of the drive sheave clockwise to close the sheave. To decrease blower speed, turn the outer side of the adjustable sheave counterclockwise to open the sheave. Each 1/2 turn of the sheave will change airflow by approximately 2-5%.
4. Retighten motor sheave set screw(s) and replace the belt(s).
5. The motor base may have to be shifted to obtain proper belt tension. The proper belt tension is achieved when there is a 3/4" deflection of the belt when a force of approximately 5 pounds is applied to the center of the belt using a belt tension gauge. Do not overtighten, otherwise belt and/or bearing life will be compromised. Refer to #5 in Figure 21.1 and Figure 22.1.
6. Recheck blower speed and air volume delivered after adjustment. Repeat the above steps until the air volume matches the rated air volume on the unit serial plate.
7. Check motor Amps to make sure the actual motor Amp draw does not exceed the motor nameplate Amp draw. If proper air flow and/or blower speed cannot be obtained, contact the factory for guidance.

FIGURE 21.1 - BLOWER AND MOTOR DRIVE

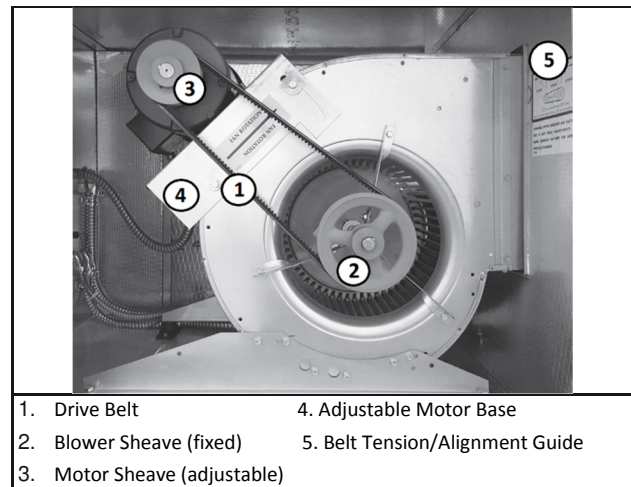

**FIGURE 22.1 - BELT TENSION ADJUSTMENT**

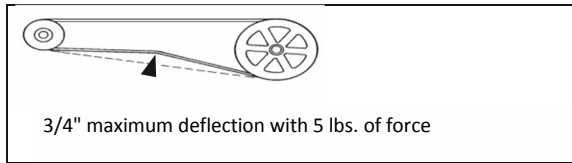

### Setting the Dirty Filter Switch (if equipped)

The dirty filter switch monitors the pressure differential between the entering air and leaving air sides of the filters. When the filters become dirty, the differential pressure increases and trips the pressure switch which energizes a light on the remote panel. If equipped with DDC controls a signal will be sent and indicated at the User Interface. The pressure differential switch must be field set because setting the switch requires the blower to be in operation and the ductwork to be installed. The range of the dirty filter pressure switch is adjustable between 0.20" to 2.0" wc

1. Ensure that the unit filters are clean. Clean or replace if necessary.
2. Connect the leads of a continuity tester to the NO and NC terminals of the dirty filter switch.
3. With the blower operating, turn the adjustment dial on the switch clockwise towards 2.0" and the continuity tester should be sensing an open circuit.
4. Begin turning the dial counterclockwise until the continuity tester senses a closed circuit. This determines the base pressure of the system.
5. Turn the dial clockwise until the continuity tester senses an open circuit and note the setting. Continue to turn the dial clockwise until it is 0.25" above the value at which the switch opened. This will allow for the increase in static pressure due to dirty filters.

**FIGURE 22.2 - DIRTY FILTER PRESSURE SWITCH**



### Commissioning

After all of the initial start-up procedures have been performed, the unit is ready for commissioning. Check the unit operation in all modes against the General Sequence of Operation on the following pages, or refer to the job specific sequence of operation included with the unit as shipped.

### Sequence of Operation - General

The following describes the general sequence of operation for the unit, however each unit may be slightly different based on unit configuration and application. Each unit includes a laminated job specific Sequence of Operation affixed to the inside of the control access door. Refer to that document for the actual unit Sequence of Operation.

#### Summer/Off/Winter Switch = "Off"

The unit is shut down with no blower or burner operation.

#### Summer/Off/Winter Switch = "Summer"

1. If timed freeze protection is furnished with the unit, the freeze protection timer will be energized at this time and will pass power to the inlet and/or discharge damper motor (if furnished with unit). It will continue to monitor the supply air temperature for a period of 5 minutes to allow steps 2 and 3 to complete. If after that 5 minutes, the supply air temperature is below the set point (typically 40°F), the dampers will close and the unit will be shutdown. This prevents inadvertent freezing of the building if the unit is placed in the "Summer" mode when it should be placed in the "Winter" mode.
2. If equipped with an inlet or discharge air damper, the actuator is energized and the dampers will open. When the damper is fully open, the actuator end switch will close and allow power to be supplied to the blower motor control circuit (motor starter or VFD).
3. With the blower motor control circuit energized, the motor starter contacts will close or the VFD will energize the motor to operate the fan.
4. The gas and temperature controls are locked out to prevent heating during the "Summer" mode of operation.
5. If equipped with a cooling section, the cooling section controls are enabled.
6. If the unit has been supplied with a dirty filter switch, the filter light will come on only if the pressure drop across the filters rises above the dirty filter switch set point.

#### Summer/Off/Winter Switch = "Winter"

1. If timed freeze protection is furnished with the unit, the freeze protection timer will be energized at this time and will pass power to the inlet and/or discharge damper motor (if furnished with unit). It will continue to monitor the supply air temperature for a period of 5 minutes to allow steps 2 and 3 to complete. If after that 5 minutes, the supply air temperature is below the set point (typically 40°F), the dampers will close and the unit will be shutdown. This prevents inadvertent freezing of the building if the unit is placed in the "Summer" mode when it should be placed in the "Winter" mode.
2. If equipped with an inlet or discharge air damper, the actuator is energized and the dampers will open. When the damper is fully open, the actuator end switch will close and allow power to be supplied to the blower motor control circuit (motor starter or VFD).
3. Before the ignition control sequence can be initiated, the following safety devices are checked for closure:
  - a. The low air flow pressure switch ensures the minimum air flow has been achieved to allow for proper ignition.

- b. The high air flow pressure switch ensures the air flow is at or below the maximum allowable to ensure clean combustion and reduced flame disturbance.
  - c. The high temperature limit control ensures the supply air temperature does not exceed the maximum allowable limit for safe operation.
  - d. If equipped with high and low gas pressure switches, the switches ensure the gas pressure is sufficient for proper ignition and safely below the maximum allowed pressure to prevent the unit from over-firing and/or damaging the gas manifold components.
  - e. If equipped with the mild temperature inlet thermostat option, this thermostat proves that the outside air temperature is low enough to allow burner operation without overheating the space and needlessly burning gas.
4. With the safety devices described in the above steps verified, the flame safeguard control is enabled to initiate the ignition sequence. After 10 seconds of pre-purge time, the ignitor is energized to produce spark ignition as follows:
    - For units with Direct Spark Ignition (no pilot line), the main valve(s) opens and with the modulating valve at minimum position, the burner is allowed to light (direct spark ignition).
    - For units with a pilot line, the pilot valve opens and the pilot is lit. Once the pilot is lit and proven with the flame rod flame sensor, the main gas valves open and with the modulating valve at minimum position, the burner is allowed to light (intermittent pilot ignition).
  5. The burner remains on low fire momentarily, then the temperature controls take over and fire the burner based on load demands.
  6. If any of the devices discussed in step #3 open, the gas circuit is disabled, the unit goes into lockout, and the burner lockout light is lit. Before resetting, a service person must inspect the unit, determine the cause, and take corrective action.
  7. If the unit has been supplied with a dirty filter switch, the filter light will come on only if the pressure drop across the filters rises above the switch set point.

### Sequence of Operation - Blower

The blower control circuit can be configured from the factory as one of the following:

1. **Single Speed Motor Starter.** When initiated, the motor starter contacts will close and the blower motor will operate at rated speed. The speed is fixed and not adjustable, however, the adjustable sheave on the motor can be adjusted.
2. **Constant Speed VFD.** When initiated, the VFD will energize the motor and will operate at a fixed frequency as configured on the order. There are typically two reasons for using this control type:
  - To provide manual adjustment of the motor speed for purposes such as one time balancing of airflow.
  - To provide soft start functionality for larger HP motors where voltage drop typical with an across the line starter is a concern.
3. **Two Speed VFD.** When initiated, the VFD will energize the motor at either the low speed or high speed, depending on the High/Low Speed switch setting. With the unit running, the speed can be changed at any time with that switch. High speed is always 100% or 60Hz while low speed is customer defined and can be as low as 35% or 21Hz.

4. **Modulating VFD Based on External Signal Input.** When initiated, the VFD will energize the motor at a frequency proportional to the input of an external control signal. The control signal can be either 4-20 mA or 0-10 Vdc. With the unit running, the speed can be changed at any time by changing the control signal level to the drive. High speed is always 100% or 60Hz while low speed is low as 35% or 21Hz. The speed is adjustable throughout the range between 35 to 100% (21 to 60Hz).

5. **Modulating VFD based on Building Pressure.** When initiated, the VFD will energize the motor at a frequency proportional to the input of an external control signal from the building pressure sensor. With the unit running, the speed will be changed automatically by the building pressure sensor. High speed is always 100% or 60Hz while low speed is low as 35% or 21Hz. The speed is adjustable throughout the range between 35 to 100% (21 to 60Hz) by the building pressure sensor.

### Sequence of Operation – Non-Recirculating Evaporative Cooler (EVN)

The non-recirculating evaporative cooling design was developed with water economy in mind. By setting the sensitivity of the liquid level controller to a very high setting, the owner can minimize wasted water while sacrificing slightly on efficiency. Even using the factory default intermediate setting for sensitivity, only small quantities of excess water drip off the media and get collected and drained away. Below is the sequence of operation for the EVN system:

1. With the Summer/Off/Winter switch in the "Summer" position the evaporative cooler circuit is enable.
2. If the unit has been ordered with the Water Supply Valve Kit with Freeze Protection, the freeze thermostat (TH2) monitors the outside air temperature to ensure it is above freezing. One of two operations can happen based on outside air (OA) temperature sensed:
  - If the OA temperature is above the set point (65°F adjustable), the Supply Water Valve (SWV) is opened and the Supply Line Drain Water Valve (DWV) is closed, permitting water to flow to the Internal Water Control Valve (IWCV).
  - If the OA temperature is below the set point (65°F adjustable), the Supply Water Valve (SWV) is closed and the Supply Line Drain Water Valve (DWV) is opened, disabling water flow to the Internal Water Control Valve (IWCV) and draining the water supply line to the unit.
3. With water permitted to flow to the IWCV, the Liquid Level Controller (LLC) monitors an outside air thermostat (TH3), and if the temperature is above the set point (75°F adjustable), the LLC will open the IWCV, allowing water to flow to the media water distribution piping, saturating the media.
4. Once the overflow water sensor (OWS) detects moisture/water, the LLC will close the IWCV.
5. With the IWCV closed, if the OWS doesn't sense moisture for a period of 30 seconds, the LLC will re-open the IWCV until the OWS senses moisture/water.
6. If TH3 detects that the outside air temperature has fallen below the set point (see step 3), the evaporative cooler circuit will be in stand-by until the temperature rises above the set point.

### Final Step

With Start-Up and Commissioning complete, set the temperature controls for automatic operation if the unit is to be put into service immediately.

If the unit is to be left off, set the Summer/Off/Winter switch to the "Off" position and turn the power off at the unit disconnect switch.

## UNIT AND ACCESSORY WEIGHTS

ALL WEIGHTS ARE APPROXIMATE AND IN LBS.

TABLE 24.1 - UNIT WEIGHTS

Item	Type	Model				
		T1	T2	T3	T4	T5
Base Unit	Unit	285	385	560	715	940
	Double Wall - Add	70	120	180	220	270
Side Access Filter Section	Filter Section	55	70	100	120	150
	Double Wall - Add	40	40	50	60	70
Damper	Inlet	25	36	46	67	100
	Discharge	25	40	45	50	60
Inlet Hood	Without Filters	35	50	65	75	100
	With Filters	40	60	75	90	120
Roof Curb	Unit without Side Access Filter Section	60	75	105	115	120
	Unit with Side Access Filter Section	85	105	130	140	145
Discharge Diffuser	3-Way with Horizontal Blades	40	45	60	70	80
	3-Way with Horizontal and Vertical Blades	45	55	70	80	95
	4-Way with Horizontal Blades	50	55	70	80	135

TABLE 24.2 - EVAPORATIVE COOLER WEIGHTS

Item	Type	Evaporative Cooler Model EVN					
		1	2	3	4	5	6
Evap Cooler Unit	Dry	100	120	150	185	235	270
	Operating	150	190	260	345	475	570
Inlet Hood	Without Filters	35	40	65	100	125	150
	With Filters	40	50	80	120	150	175
Side Access Filter Section	With Filters	10	15	15	20	25	30

TABLE 24.3 - MOTOR WEIGHTS

Motor Size	Enclosure Type	Motors		Factory Mounted VFD
		Single Phase	Three Phase	
0.50 HP	ODP	20	N/A	10
	TEFC	25	35	
0.75 HP	ODP	25	N/A	10
	TEFC	30	40	
1.00 HP	ODP	40	N/A	10
	TEFC	40	45	
1.50 HP	ODP	45	N/A	10
	TEFC	70	55	
2.00 HP	ODP	50	N/A	10
	TEFC	75	85	
3.00 HP	ODP	90	90	15
	TEFC	100	95	
5.00 HP	ODP	100	115	15
	TEFC	125	130	
7.50 HP	ODP	130	125	15
	TEFC	145	150	
10 HP	ODP	215	215	30
	TEFC	220	220	
15 HP	ODP	N/A	230	30
	TEFC	N/A	250	



# MAINTENANCE

## WARNING

1. Disconnect power supply before maintaining the equipment to prevent electrical shock and equipment damage.
2. If equipped with the factory installed disconnect switch option, when the switch is in the "OFF" position, supply power remains energized at the supply power terminal strip and the top of the disconnect switch. When providing service on or near these terminals, building supply power to the unit should be de-energized.

## CAUTION

When using a drill bit to clean the burner gas ports, do not distort or enlarge the ports. Use a pin vise not a power drill.

## IMPORTANT

1. Service and maintenance procedures should be performed by a qualified service agency.
2. When lubricating bearings, be sure to keep the grease clean, do not over-lubricate, and do not mix petroleum grease with silicone.

All heating equipment should be serviced before each heating season to assure proper operation. The following items may be required to have a more frequent service schedule based on the environment in which the unit is installed, and how long the equipment is operated.

### Motor Assembly

Check the motor sheave set-screws and the motor slide base bolts for tightness upon initial start-up and before each heating season. The motor bearings are pre-lubricated at the factory for initial operation but should be re-lubricated (when provided with grease fittings) at six (6) month intervals. The recommended lubricants are Shell Oil Company "Dolium R", Chevron Oil "SRI No. 2", or Texaco "Premium RB" lubricant. When lubricating, consider the following:

- Clean the grease fitting and then apply the grease with a proper grease gun. Keep grease clean.
- Use two full strokes for each bearing. Do not over-lubricate.
- Do not mix petroleum grease with silicone.
- Lubricate motors at standstill.

### Blower Assembly

After initial start-up, check the tightness of the fan sheave, fan hub set screws, fan bearing collar set screws, and fan bearing mounting bolts. Also, when tensioning the v-belts, when lubricating the fan bearings, and before each heating season. Examine the blower wheel at six (6) month intervals for accumulation of dust and dirt on the fan blades. Any build-up must be cleaned off to maintain performance. If the accumulation is heavy, more frequent cleaning may be required.

### Sheaves

Drive sheaves should be checked at the same time the bearings are inspected. Check to make sure the pulleys are in alignment and are securely fastened to the blower and motor drive shafts.

### Blower Bearing Lubrication

Models with spider bearings are pre-lubricated which require no additional lubrication for the life of the bearing.

Models with pillow block bearings and should be lubricated annually using ESSO Beacon 325, Shell Alvania #3, or an

equivalent. Clean the grease fitting and then apply the grease with a proper grease gun. Inject enough grease until a small amount shows between the seal and the bearing race.

### Belts

Due to belt stretching, adjust belt tension after the first one hundred (100) hours of operation. Check belts every three months thereafter for proper tension. Do not over tighten. Adjustment should result in a belt deflection of 3/4" to 1" for each foot of span when applying medium thumb pressure inward at the center of the span.

### Filters

Inspect monthly or as indicated by the dirty filter light on the remote panel until an appropriate schedule can be established, based on need. Replace or clean as necessary.

### Burner

Annually, prior to each heating season, a check should be made of the burner and components. Clean the igniter and flame rod and examine porcelain for cracks. Perform the following:

1. Inspect the burner carefully, including upstream and downstream sides of mixing plates as well as burner body face. Any accumulation of scale or foreign material on either side of the mixing plates should be removed with a wire brush. Check visually that no holes in the mixing plates are blocked. If any mixing plates are loose or missing fasteners, tighten/replace as necessary. Always use zinc plated or stainless fasteners.
2. Check burner orifices for carbon build-up and clean. Use a pin vise with a drill bit for cleaning as follows:
  - #43 (#47 at tee sections, if equipped) drill bit for Maxon NP-I burner orifices
  - #31 drill bit for Midco natural gas burner orifices
  - #45 drill bit for Midco propane gas burner orifices
  - #50 (1/16") drill bit for Maxon NP-II burner orifices.

## DO NOT ENLARGE BURNER ORIFICES - THIS MAY AFFECT PERFORMANCE

FIGURE 25.1 - BURNER ORIFICES (direct spark ignition shown)

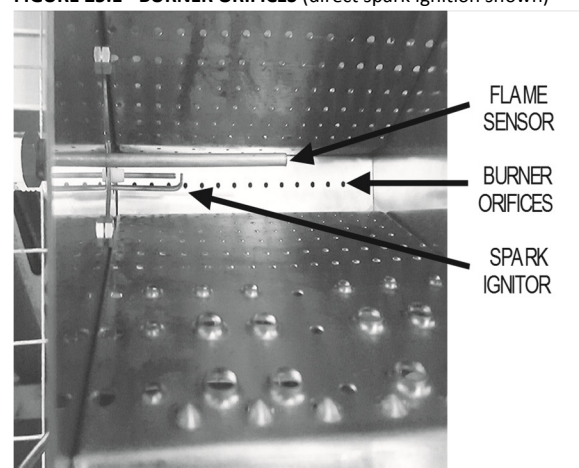

### Gas Train

An annual inspection of the gas control assembly should be made. Internal and external piping should be checked for leaks. Relief vents on gas controls should be checked for clogging.

### Air Pressure Switches

An annual check of the tube for the air flow switch, and the entering and leaving side of building pressure switches, should be made to ensure against blockage.

### Dampers

Check damper linkage connection and/or set screws for tightness. Lubricate the damper bushings as required.

### Casing

For painted units, periodically touch up any scratches.

### Gaskets

Inspect door gasket seals annually. Replace any showing damage or deterioration.

### Discharge Air Sensor

Remove the cover from the sensor assembly junction box (Item #7 in Figure 12.1) which will expose the sensor module (Figure 26.1). Remove the two screws that hold the sensor module in the junction box. The sensor assembly junction box does not get removed. Insert a bottle brush into the sensor sampling tube to clean out any dust or dirt, then replace the sensor module and junction box cover.

**FIGURE 26.1 - DISCHARGE AIR SENSOR ASSEMBLY**

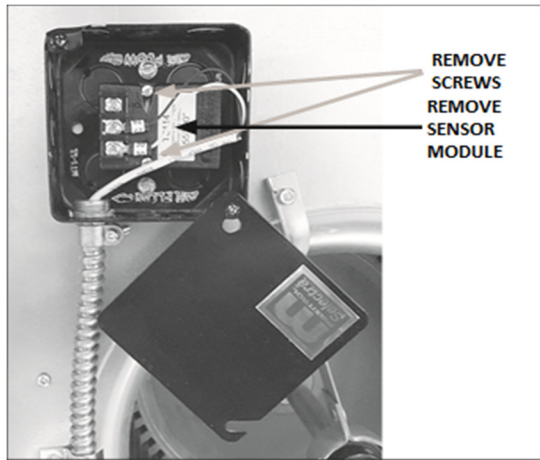

### Gas and electric controls

Inspect for general cleanliness and tightness of electric and mechanical connections.

Put the system back into operation and view the burner from the downstream side while cycling the burner through its full firing range. A good flame will be blue, with minimal yellow "fingers". The flame length in forced "high fire" should be 12-18" long. The pilot only flame should be about the size of a baseball when properly adjusted.

### Procedure for extended shutdown Periods

If the unit is to be shut down for an extended period of time, the following precautions should be followed:

1. Turn off all manual shutoff valve(s) in the gas train of the unit, and in the gas supply line to the unit.
2. Turn off the electric supply to the unit at the unit disconnect. Lock the disconnect to prevent tampering.
3. If the unit is supplied with filters, remove and store the filters.
4. Protect outside air openings to prevent the unit from being soiled.

## SERVICE AND TROUBLESHOOTING

WARNING		CAUTION	
When servicing or repairing this equipment, use only factory-approved service replacement parts. A complete replacement parts list may be obtained by contacting the factory. Refer to the rating plate on the unit for complete unit model number, serial number, and company address. Any substitution of parts or controls not approved by the factory will be at owner's risk.		Do not reuse any mechanical or electrical component which has been wet. Such components must be replaced.	
		IMPORTANT	
		To check most of the Possible Remedies in the troubleshooting guide listed, refer to the applicable sections of the manual.	
Problem	Possible cause	Possible remedy	
<b>A. Power Failure</b>	1. Disconnect not turned on.	1. Turn to disconnect.	
	2. Blown fuses.	2. Check and replace.	
	3. Main to unit disconnect not on.	3. Turn on power at main.	
<b>B. Dampers Not Operating</b>	1. Disconnect not turned on.	1. Turn to disconnect.	
	2. Blown fuses.	2. Check and replace.	
	3. Main to unit disconnect not on.	3. Turn on power at main.	
	4. Failed damper motor.	4. Check and/or replace.	
	5. Loose wiring to motor.	5. Check and tighten.	
	6. Damper linkage binding.	6. Check and clear.	
<b>C. Motor Not Operating</b>	1. Disconnect not turned on.	1. Turn to disconnect.	
	2. Blown fuses.	2. Check and replace.	
	3. Main to unit disconnect not on.	3. Turn on power at main.	
	4. Failed motor.	4. Check and/or replace.	
	5. Loose wiring to motor.	5. Check and tighten.	
	6. Motor overloaded.	6. Check for proper speed.	
	7. Improper supply voltage.	7. Check and correct.	
	8. Motor overheating.	8. Check firing rate of unit.	
<b>D. Blower Not Operating</b>	1. See Problems "A" and "C".	1. See Problems "A" and "C".	
	2. Broken drive belt(s).	2. Check and replace.	
	3. Bearings seized.	3. Check and replace.	
<b>E. Burner Not Operating</b>	1. See Problems "A" thru "D".	1. See Problems "A" thru "D".	
	2. Damper end switch not functioning.	2. Check and/or replace.	
	3. Failed air flow switch.	3. Check and/or replace.	
	4. Loose wiring connection at air proving.	4. Check and tighten.	
	5. No pilot.	5. See Problem "F".	
	6. Pilot not proving.	6. See Problem "F".	
	7. Flame safeguard in lockout mode.	7. Check and reset.	
	8. High limit tripped.	8. Check and/or replace.	
	9. Too high or low gas pressure.	9. Check pressure switches and gas pressure.	
	10. Failed control transformer.	10. Check and/or replace.	
	11. Blown control transformer fuse.	11. Check and/or replace.	
	12. Failed or malfunctioning main gas valve(s).	12. Check and/or replace.	
	13. Faulty or failed freeze stat or inlet on/off stat.	13. Check and/or replace.	
	14. Failed safeguard control.	14. See vendors instructions shipped with unit.	
	15. Airflow too low, low airflow proving switch is open.	15. Check for reason of insufficient airflow and correct.	
	16. Airflow too high, high airflow cutoff switch is open.	16. Check for reason of excessive airflow and correct.	

<b>Problem</b>	<b>Possible cause</b>	<b>Possible remedy</b>
<b>F. Pilot Not Operating</b>	1. No gas to pilot.	1. Check hand valve and pilot solenoid valve.
	2. Dampers not functioning.	2. See Problem "B".
	3. Pilot tube plugged or damaged	3. Check and repair/or replace.
	4. Freeze stat failure.	4. Check and/or replace.
	5. Inlet On/Off stat failure.	5. Check and/or replace.
	6. Flame safeguard in lockout	6. Check and reset.
	7. Failed flame safeguard.	7. See vendor's instructions shipped with unit.
	8. Failed air flow switch	8. Check and/or replace.
	9. Too high or low gas pressure.	9. Check pressure switches and gas pressure.
	10. See Problem "E" – No Burner	10. See Problem "E" Operation.
<b>G. Flame Will Not Prove</b>	1. Inadequate signal to safeguard control.	1. Check micro-Amps or Vdc from flame sensor.
	2. Insufficient gas pressure to pilot.	2. Check and adjust.
	3. Loose wires from flame sensor.	3. Check and correct.
	4. Dirty flame rod.	4. Clean and/or replace.
	5. Moisture on flame rod leads.	5. Check and dry leads.
	6. Defective flame rod.	6. Check and/or replace.
	7. Defective flame safeguard controller.	7. Check and/or replace.
	8. Short in flame sensor leads.	8. Check and/or replace.
	9. Excessive air velocity across burner.	9. Check burner velocity and correct.
<b>H. Erratic Temperature</b>	1. Defective temperature selector or sensor.	1. Check and/or replace.
	2. Temperature sensor subject to poor air flow or located in drafty area.	2. Check sensor location and move if required.
	3. Discharge sensor blocked by duct insulation.	3. Check and remove blockage.
	4. Faulty amplifier or modulating valve.	4. Check and/or replace.
<b>I. Unable to Achieve High Fire</b>	1. Low gas supply pressure.	1. Check and adjust.
	2. Modulating controls improperly set.	2. See vendor literature shipped with unit.
	3. Faulty temperature sensor.	3. Check and/or replace.
	4. Faulty amplifier or modulating valve.	4. Check and/or replace.
<b>J. Unable to Achieve Low Fire</b>	1. Modulating controls improperly set.	1. See vendor literature shipped with unit.
	2. Faulty temperature sensor.	2. Check and/or replace
	3. Faulty amplifier or modulating valve.	3. Check and/or replace.
<b>K. No Gas Flow</b>	1. Manual gas valve(s) closed.	1. Open manual gas valve(s).
	2. See Problem "E", Items 2 thru 14.	2. See Problem "E", Items 2 thru 14.
<b>L. Unable to Achieve Desired Discharge Temperature, or Space Temperature</b>	1. Temperature sensors improperly set or faulty.	1. Adjust or replace.
	2. Improper gas supply pressure.	2. Check and correct.
	3. Faulty amplifier or proportioning motor.	3. See vendor literature shipped with unit.
	4. Air flow too high.	4. Check blower speed and/or burner velocity differential pressure.
	5. Burner capacity undersized.	5. Check rating plate for conformance to design specifications.
<b>M. Building Pressure Control VFD Control Functioning Incorrectly or Not Functioning</b>	1. Defective building pressure switch.	1. Check and/or replace.
	2. Pressure switch improperly set.	2. See vendor literature shipped with unit.
	3. Pressure switch pick-up tubes blocked.	3. Check and repair or reconnect.
	4. Indoor pressure pick-up tube not routed to indoor space.	4. Route tube to indoor space.
	5. Faulty VFD.	5. Check and/or replace.

# T-SERIES

## START-UP CHECK LIST AND REPORT

### IMPORTANT

1. This Start-Up Check List and Report must be used in conjunction with the Installation and Service Manual originally shipped with the unit, in addition to any other accompanying component supplier literature.
2. The use of this Start-Up Check List and Report is specifically intended for a qualified installation and service agency. All installation and service of the unit(s) to which this applies must be performed by a qualified installation and service agency.
3. After completion of start-up, make a copy of this completed form for your files as necessary and leave the original copy with the owner for future reference.

<b>PROJECT INFORMATION</b>	<p>Project Name: _____</p> <p>Address: _____</p> <p>City, State, ZIP: _____</p>
<b>EQUIPMENT INFORMATION</b>	<p>Model #: _____</p> <p>Serial #: _____</p>
<b>START-UP CONTRACTOR INFORMATION</b>	<p>Company Name: _____</p> <p>Contact Name (print): _____</p> <p>Contractor Address: _____</p> <p>Telephone #: _____</p>
<b>OWNER OPERATION AND MAINTENANCE REVIEW</b>	<p>Owner/Owner's Rep Name: _____</p> <p>Title: _____</p> <p><b>CUSTOMER'S AUTHORIZED SIGNATURE:</b> I acknowledge that I have been instructed on the operation and maintenance of this equipment.</p> <p>Signature: _____ Date: _____</p> <p>Telephone #: _____</p>
<b>THIS MANUAL IS THE PROPERTY OF THE OWNER. PLEASE BE SURE TO LEAVE IT WITH THE OWNER WHEN YOU LEAVE THE JOB.</b>	



Customer: \_\_\_\_\_

Sales Representative: \_\_\_\_\_

Model Number: \_\_\_\_\_

Serial Number: \_\_\_\_\_

# Field Start-Up Sheet

## Direct Gas Fired Equipment

\*\*\*Please Print\*\*\*

### INITIAL INSPECTION

#### I. Installer Responsibilities

1. Remote Panel: all interconnecting wires run from remote to unit:  Yes  N/A
- Temperature control interconnect wires to remote ran in:  Shielded Cable  Separate Conduit
- Remote Panel Location: \_\_\_\_\_ Feet from unit (approx.)  Inside Wall  Outside Wall

**PLEASE NOTE: if the Remote to Main Panel Interconnect Wiring is over 200' Long, Please Consult Factory!!**

2. Gas supply connected with proper gas regulator, drip leg, etc.:  Yes  No
3. Electrical supply connected with proper voltage/amperage, as stated on nameplate:  Yes  No
4. All electrical connections on all components are tight, including motor connections:  Yes  No
5. Duct connections made and sealed properly:  Yes  No
6. All paint scratches have been properly touched-up:  Yes  N/A
7. Multi-section units: joints caulked, nuts/bolts installed and tight, seam tape applied:  Yes  N/A
8. Discharge head installed secure, with diffuser blades tightened in the open position:  Yes  N/A
9. All "shipped loose" items installed properly (i.e.: roof curb, filters, vibration isolators, smoke detector, discharge damper, etc.):
- Yes  No Comments: \_\_\_\_\_

## II. Miscellaneous Items

1. Visible Physical Damage:     No                       Yes; Explain: \_\_\_\_\_
2. Installation Location:         Outdoor             Indoor
3. Mounting Type:                 Roof Curb         Steel/Platform         Post & Rail         Suspended         Ground/Floor
4. Hardware Tight & Secure:     Yes                 No                      5. Damper Linkages Secure:         Yes                 N/A

Comments: \_\_\_\_\_

## III. Fan & Motor Sheaves

1.  Fan & Motor Sheaves Secured Tightly to Shafts                       Fan Belt(s) Aligned & Tensioned Properly
2.  Fan Bearing & Hub Set Screws Tight                                       Fan Bearing Mounting Bolts Tight
3.  Motor Wiring Connections Tight
4. Motor Sheave P/N: \_\_\_\_\_                                      Fan Sheave P/N: \_\_\_\_\_
5. Motor Manufacturer: \_\_\_\_\_                                      HP: \_\_\_\_\_ FLA: \_\_\_\_\_ Frame Size: \_\_\_\_\_

Comments: \_\_\_\_\_

## IV. Burner Inspection

1.  Spark Igniter Secured Properly                      -or-                       UV Scanner Properly
2.  Flame Rod Secured Properly                      -or-                       Pilot Line Fittings Tight
3.  Ignition Wire Attached at Igniter & Transformer
4.  Unions Tight and Secure

Comments: \_\_\_\_\_

## V. Gas Manifold & Vent Piping

- Manifold Assembly Components Tight & Securely Mounted                       All Fittings and Components Tight & Securely Mounted
- Vent Screens Installed (if applicable)                                       Vent Piping Run to Outdoors (if applicable)

Comments: \_\_\_\_\_

## VI. Filters

- Filters Installed Properly – type of filter:     Aluminum         Pleated 30%         Pad & Frame         Other \_\_\_\_\_

Comments: \_\_\_\_\_

## VII. Electric Service

1. Electrical Service Provided to Unit: \_\_\_\_\_ Volts \_\_\_\_\_ Phase \_\_\_\_\_ Hertz \_\_\_\_\_ Amps
2. Unit Nameplate Electrical Requirements: \_\_\_\_\_ Volts \_\_\_\_\_ Phase \_\_\_\_\_ Hertz \_\_\_\_\_ Amps
3. Main Fusing Size (if applicable): \_\_\_\_\_ Volts \_\_\_\_\_ Amps
4. Overload Relay Setting (if applicable): \_\_\_\_\_ Amps
5. Terminal Strip Wires Tight & Secure at: **Main Panel:**  Yes **Remote Panel:**  Yes  N/A
6. Componentry and Relays Mounted Securely in Place:  Yes
7. Unit has been grounded by installer at the main unit panel:  Yes

Comments: \_\_\_\_\_

## VIII. Gas Service (see maximum and minimum gas pressure requirements on unit rating plate)

1.  Natural Gas  LP Gas Service Pressure: \_\_\_\_\_ " wc - or - \_\_\_\_\_ oz. - or - \_\_\_\_\_ psig
2. Manual Gas Shut-off Cock in line-of-sight:  Yes  No
3. Handle Present on Manual Shut-off Cock:  Yes  No

Comments: \_\_\_\_\_

# VERIFICATION OF OPERATION

**NOTE: Refer to the Sequence of Operation & Wiring Diagram in the Owner's Manual for specific data on this unit.**

**See Factory Start-up & Test Sheet in the Unit Owner's Manual to note the unit settings prior to shipment.**

## I. Fan Operation

1. The Inlet Damper is fully open & operates properly when fan comes on:  Yes  N/A
2. The Discharge Damper is fully open & operates properly when fan comes on:  Yes  N/A
3. The low temperature limit switch is field set at: \_\_\_\_\_ °F (factory set at 40°F)  Yes  N/A
4. The low temp. limit bypass timer is field set at: \_\_\_\_\_ mins. (factory set at 5 mins.)  Yes  N/A
5. Fan Rotation is in the same direction as the rotation arrow (on fan):  Yes

**Actual Fan RPM:** \_\_\_\_\_

6. Discharge External Static Pressure at: **Rating Plate:** \_\_\_\_\_ " wc **Actual:** \_\_\_\_\_ " wc



7. Check the following:

<u>Unit Off</u>		<u>Unit On/Fan Running (burner off)</u>		
A-B	_____ Volts	A-B	_____ Volts	_____ Amps <i>Verify the motor running</i>
B-C	_____ Volts	B-C	_____ Volts	_____ Amps <i>Amps does not exceed the</i>
A-C	_____ Volts	A-C	_____ Volts	_____ Amps <i>motor nameplate FLA!</i>

8. Approximate Outdoor Air Temperature: \_\_\_\_\_ °F

## II. Burner Operation

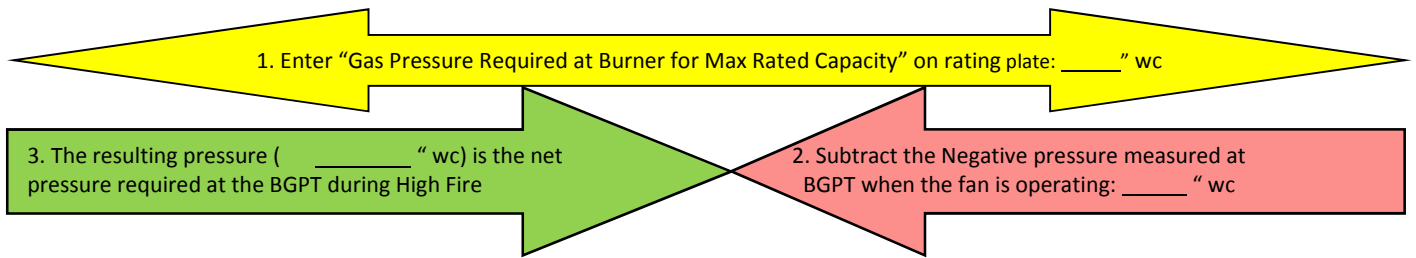

### Forcing High Fire

Δ- Maxitrol 14 System – Disconnect wire 29

Δ- Maxitrol 44 System – disconnect wires 24 and 29

Δ- Maxitrol DFM44 System – Jumper wires 29 and 30

Δ- Maxitrol Signal Conditioner – Full mA or Vdc signal

**Example:** 4.6" wc on rating plate – 1.2" wc burner suction (measured with just fan running = 3.4" wc net measured at the BGPT.

4. The Profile Pressure Drop is: \_\_\_\_\_ " wc (measured using high & low-pressure ports)

5. The Burner Suction Static Pressure is: \_\_\_\_\_ " wc (measured at the manifold pressure tap with unit fan on and gas off)

6. The Burner High Fire Pressure is: \_\_\_\_\_ " wc (measured as above, but with fan and gas on, and unit in forced high fire)

7. The Service Pressure with burner *in high fire* is: \_\_\_\_\_ " wc - or - \_\_\_\_\_ oz. - or - \_\_\_\_\_ psig

8. The High Temperature Limit Switch is field set to: \_\_\_\_\_ °F (maximum setting is 150°F)  Yes

9. The Low Gas Pressure Switch is field set to: \_\_\_\_\_ " wc (factory set at 3" wc)  Yes  N/A

10. The High Gas Pressure Switch is field set to: \_\_\_\_\_ " wc (factory set at 1.5" wc above high fire pressure)  Yes  N/A

11. The Pilot Flame should be the approximate size of a baseball (adjust as needed):  Yes  N/A

12. Set the burner low-fire gas pressure so there is a continuous "ribbon" of flame approximately 1" wide across face of burner.

13. Flame Relay. If a Honeywell model, it should read **1.25 to 5.0 Vdc** at terminals marked (+ -) on the flame relay face, if Fireye, it should read **4.0 to 10.0 Vdc** at terminals marked (+ -) on the flame relay face.

14. The mild weather stat (disables burner at OA set point) is field set at: \_\_\_\_\_ °F (factory set at 65°F):  Yes  N/A

### III. Space Temperature Control Systems (Maxitrol 44)

1. Modulating Regulator Valve ("MR Valve") Voltage at Low Fire: \_\_\_\_\_ Vdc Voltage at High Fire: \_\_\_\_\_ Vdc
2. The Minimum Discharge Temp. is field set at: \_\_\_\_\_ °F (factory set at 55°F)  Yes  N/A
3. The Maximum Discharge Temp. is field set at: \_\_\_\_\_ °F (factory set at 95°F; max. setting is 120°F)  Yes  N/A
4. Burner responds to demand for heat from Room Temperature Selector in remote panel:  Yes  N/A
5. Check calibration of the minimum/maximum discharge temperature control. Adjust if necessary.
6. Operation of Occupied/Unoccupied Switch and/or Time Clock verified:  Yes  N/A
7. Is there evidence of temperature hunting?  Yes  No

### Space Temperature Control System (BMS or Internal DDC)

1. Input signal from BMS:  0-10 Vdc  4-20 mA

### IV. Discharge Temperature Control Systems (Maxitrol 14 Series)

1. Modulating Regulator Valve ("MR Valve") Voltage at Low Fire: \_\_\_\_\_ Vdc Voltage at High Fire: \_\_\_\_\_ Vdc
2. Check calibration of the Discharge Air Temperature Selector. Adjust if necessary.
3. Is there evidence of temperature hunting?  Yes  No

**\*\* Refer to the Maxitrol Troubleshooting Guide in the Owner's Manual for further instructions**

Comments: \_\_\_\_\_

### V. Variable Frequency Drive Operation

1. VFD speed reference/control signal:  High/Low Volume Switch  Building Pressure (control) via Transmitter  
 High/Low Volume (via relay)  Manual Potentiometer  
 0-10 Vdc Input (by others)  4-20 mA Input (by others)  Other \_\_\_\_\_
2. Does the burner profile stay within airflow parameters when the fan ramps up and ramps down:  Yes  No

### VI. Miscellaneous Operational Checks:

1. With the unit fan and burner operating, all of the circuit check lights are illuminated (except the burner lock-out pilot light and the low temperature switch pilot light):  Yes  N/A
2. The time clock has been programmed per owner instructions & owner training has been provided:  Yes  N/A
3. If provided, the following temperature control stats have been set by me, and instructions provided to the owner:

\_\_\_\_\_ Cycle Stat    \_\_\_\_\_ Cool-down Stat    \_\_\_\_\_ Mild Weather Stat    \_\_\_\_\_ Freeze Stat



**THE ABOVE START-UP WAS PERFORMED BY:**

Company Name: \_\_\_\_\_ Date: \_\_\_\_\_

Ph. Number: (     ) \_\_\_\_\_ Fax Number: (     ) \_\_\_\_\_

My Name (Service Tech): \_\_\_\_\_

**-- MAKE A COPY FOR YOUR FILES AS NECESSARY --**

**The Owner Representative that I met with and discussed the unit controls and operation was:**

**NAME:** \_\_\_\_\_ **TITLE:** \_\_\_\_\_

**(please print)**

**CUSTOMER'S AUTHORIZED SIGNATURE**

I acknowledge that I have been instructed on the operation of this unit:

Signature: \_\_\_\_\_ Date: \_\_\_\_\_ Ph. No.: \_\_\_\_\_

**After Completion, Return this start-up sheet to:**

**NAKS, Inc.**

172 Reaser Court

Elyria, OH 44035-1377

Ph.: (800) 854-3267 Fax: (440)365-2100



Email: [sales@hoodmart.com](mailto:sales@hoodmart.com)

Website: [www.hoodmart.com](http://www.hoodmart.com)

# REPLACEMENT PARTS ORDERING

## Serial Plate Example

When servicing, repairing or replacing parts on these units, locate the serial plate of the unit and always give the complete model number and serial number as seen highlighted in yellow in the example below from the serial plate. The serial plate is located on the door of the electrical control box.

 <b>NORTH AMERICAN KITCHEN SOLUTIONS INCORPORATED</b> 172 REASER COURT * ELYRIA, OH 44035-1377 PH.: (800) 854-3267 * FAX: (440) 365-2100		 <b>ANSI Z83.4-2015/CSA 3.7-2015</b> NON-RECIRCULATING DIRECT FIRED INDUSTRIAL AIR HEATER FOR INDUSTRIAL/COMMERCIAL USE Intertek 55094	
MODEL NO.	T3-HOXEYN	SERIAL NO.	32077
<b>AIR FLOW INFORMATION</b>			
EQUIPPED FOR	3,600 ACFM (1.699 Am <sup>3</sup> s)		3,297 SCFM (1.556 Sm <sup>3</sup> s)
AGAINST	0.50" WC (0.1245 kPa)	EXTERNAL STATIC PRESSURE	
FOR INSTALLATION ON NONCOMBUSTIBLE CONSTRUCTION ONLY			
<b>GAS &amp; BURNER INFORMATION</b>			
GAS PRESSURE REQUIRED AT THE BURNER FOR MAXIMUM RATED CAPACITY		1.5" WC	GAS TYPE NATURAL
RATED BURNER CAPACITY	MAX.	307 MBH	MIN. 30 MBH
GAS INLET SUPPLY PRESSURE	MAX.	14" WC	MIN. 6" WC
BURNER PROFILE PRESSURE DIFFERENTIAL	MAX.	1.0" WC	MIN. 0.4" WC
MAX. DISCHARGE TEMPERATURE	130° F	MAX. TEMPERATURE RISE	75° F
<b>MOTOR &amp; ELECTRICAL INFORMATION</b>			
230	VOLTAGE	1	PHASE 60 CYCLES
2.00	MOTOR HP	10.00	MOTOR FLA 13.00 UNIT FLA
NOTE: FOR CONNECTIONS, USE WIRES SUITABLE FOR AT LEAST 75° C (170° F)			
<b>INSTALLATION CONDITIONS</b>			
-20° F	MINIMUM AMBIENT AIR TEMPERATURE		
MINIMUM CLEARANCES TO COMBUSTIBLES ON THE SIDES, FRONT, BACK, TOP AND BOTTOM IS 6". MINIMUM CLEARANCE FOR MAINTENANCE AT THE UNIT INLET IS 36". UNIT SUITABLE FOR INDOOR OR OUTDOOR INSTALLATION. TO SHUT DOWN THE UNIT, TURN THE MAIN DISCONNECT TO THE OFF POSITION. SEE OPERATION & MAINTENANCE MANUAL FOR ALL GAS & ELECTRICAL SCHEMATICS.			
<b>FOR YOUR SAFETY</b>			
IF YOU SMELL GAS: 1. OPEN WINDOWS 2. DON'T TOUCH ELECTRICAL SWITCHES 3. EXTINGUISH ANY OPEN FLAME 4. IMMEDIATELY CALL YOUR GAS SUPPLIER		THE USE AND STORAGE OF GASOLINE OR OTHER FLAMMABLE VAPORS AND LIQUIDS IN THE VICINITY OF THIS APPLIANCE IS HAZARDOUS.	
<b>POUR VOTRE SÉCURITÉ</b>			
SI VOUS SENTEZ UNE ODEUR DE GAZ: 1. OUVREZ LES FENÊTRES 2. NE TOUCHEZ À AUCUN INTERRUPTEUR 3. ÉTEIGNEZ TOUTE FLAMME NUE 4. ADVERTISSEZ IMMÉDIATEMENT VOTRE FOURNISSEUR DE GAZ		IL EST DANGEREUX D'UTILISER OU D'ENTREPOSER DE L'ESSENCE OU AUTRES VAPEURS INFLAMMABLES DANS DES RÉCIPIENTS OUVERTS À PROXIMITÉ DE CET APPAREIL.	



## TERMS AND CONDITIONS OF SALE

THESE TERMS AND CONDITIONS OF SALE ("TERMS") CONTAIN VERY IMPORTANT INFORMATION REGARDING YOUR PURCHASE, AS WELL AS CONDITIONS, LIMITATIONS, AND EXCLUSIONS THAT APPLY TO YOU AND YOUR PURCHASE. PLEASE READ THEM CAREFULLY. YOUR PURCHASE IS EXPRESSLY LIMITED TO AND MADE CONDITIONAL UPON THE EXCLUSIVITY OF THESE TERMS. ANY PROPOSAL FOR DIFFERENT TERMS OR ANY ATTEMPT TO VARY, IN ANY DEGREE, ANY OF THESE TERMS IS EXPRESSLY REJECTED.

- 1. Acceptance.** These Terms govern any purchase made from North American Kitchen Solutions Incorporated ("NAKS"). These Terms, the Manual in which they are contained, installation and maintenance instructions, the applicable invoice, and any documents incorporated or referred to herein or therein, including any future paper or electronic releases issued by NAKS, constitute the "Order." The Order is the entire contract between you, the buyer, and NAKS, the seller, for products purchased from NAKS. These Terms apply to the Order unless expressly modified or waived by an officer of NAKS. An Order may only be cancelled by you upon payment of reasonable cancellation charges for expenses incurred or commitments made by NAKS. Captions in these Terms are for convenience only.
  - 2. Pricing.** The price for NAKS' goods, material, equipment, or items ("Products") is complete, and no deductions, credits, or offsets may be made without NAKS' express written consent. Prices are subject to change and surcharges in the event of cost increases in materials and transportation. All complete component accessory material manufactured by others and furnished with Products such as motors, drives, vibration equipment, controls, or other completely assembled component structures, are subject to adjustment to the price at time of shipment regardless of the date of original order entry.
  - 3. Sales and Similar Taxes.** NAKS' prices do not include sales, use, excise, or similar taxes. Present or future sales, use, excise, or other similar tax applicable to the sale of Products shall be paid you, unless an acceptable tax exemption certificate is provided to NAKS.
  - 4. Payment.** NAKS reserves the right to require full or partial payment in advance of any order if, in NAKS judgement, the financial condition of buyer does not justify continuation of manufacture or shipment. NAKS may require full or partial payment in advance. Pro-rata payments are due as shipments are made. Each shipment or delivery shall constitute a separate sale, and the default of any shipment or delivery shall constitute a separate sale, and the default of any shipment or delivery shall not vitiate the contract as to other shipments or deliveries.
  - 5. Delivery.** Shipping and delivery dates are estimates only. No delay in delivery will subject NAKS to any costs, damages or fees for late delivery. Delivery of Products is made F.O.B. point of shipment, unless otherwise stated. NAKS shall not be liable for delay due to causes beyond its reasonable control (i.e., force majeure events). In the event of such a delay, the date of delivery shall be extended for a period equal to the time lost by reason of the delay.
  - 6. Changes.** NAKS may make changes, including improvements and additions, in the technical requirements, specifications, designs, materials, packaging, and place of delivery, method of transportation, quantities, or delivery schedules of the Products by notifying you.
  - 7. Safety.** The Products may be designed to serve multiple applications. NAKS offers a range of safety equipment, including guards and other devices, as may be required to meet customer specifications. Without exception, NAKS recommends that all orders include applicable safety devices. Use of Products ordered without applicable safety devices are your sole responsibility. You warrant that you have determined and acquired any and all safety devices required for the Products. Weather covers and guards for motor and V-belt drives, couplings, shafts and bearings, along with inlet and outlet screens, are optional accessories noted in the price list.
  - 8. Title.** Title and right of possession of Products remains with NAKS until all payments (including deferred payments whether evidenced by notes or otherwise) shall have been received to the satisfaction of NAKS and you agree to do all acts necessary to perfect and maintain such title and right in NAKS and not to subject any Products to any liens or encumbrances until such payment is made in full.
  - 9. Governing Law.** This Order shall be governed by and construed according to the laws of the State of Ohio (excluding the conflict of law provisions thereof). At NAKS' discretion, any action relating directly or indirectly to the Order shall be brought exclusively in the Common Pleas Court of Cuyahoga County, Ohio or the United States District Court for the Northern District of Ohio, Eastern Division, and you irrevocably waive any objection to the jurisdiction of, or venue in, either of these courts and agree that the acceptance of the Order constitutes doing business in the State of Ohio.
  - 10. Arbitration.** At NAKS' discretion, any dispute arising under or in connection with any Order may be submitted to binding arbitration administered by the American Arbitration Association under its Commercial Arbitration Rules, and judgment on the award rendered by the arbitrator may be entered in any court having jurisdiction thereof. The dispute shall be resolved by one neutral arbitrator who shall have no affiliation with either you as the buyer or with NAKS and shall be selected by the American Arbitration Association office, and held in, Cleveland, Ohio.
- WARNING.** NAKS' Products are designed and manufactured to provide reliable performance but they are not guaranteed to be 100% free of defects. Even reliable products will experience occasional failures and this possibility should be recognized by the buyer and all end users. If Products are used in life support ventilation systems where failure could result in loss or injury, the buyer and all end users should provide adequate back-up ventilation, supplementary natural ventilation or failure alarm system, or acknowledge willingness to accept the risk of such loss or injury. DO NOT USE IN HAZARDOUS ENVIRONMENTS where fan's electrical system could provide ignition to combustible or flammable materials unless unit is specifically built for hazardous environments. Comply with all local and national safety codes including the National Electrical Code (NEC) and National Fire Protection Act (NFPA).
- CAUTION.** Guards must be installed when fan is within reach of personnel or within eight (8) feet (2.5 m) of working level or when deemed advisable for safety.
- DISCLAIMER.** NAKS has made a diligent effort to illustrate and describe the Products accurately in all materials; however, such illustrations and descriptions are for the sole purpose of identification and do not express or imply any warranty.

## LIMITED WARRANTY

**WARRANTY AND DISCLAIMER.** This limited warranty extends to you the original purchaser only with proof of purchase. NAKS warrants that Products shall be free from original defects in workmanship and materials for two years from date of shipment (except for the warranty periods noted for products listed below), provided the Products have been properly handled, stored, installed, serviced, maintained and operated. This warranty shall not apply to Products which have been altered or repaired without NAKS' express authorization, or altered or repaired in any way so as, in NAKS' judgment, to affect performance or reliability, nor which have been improperly installed or subjected to misuse, negligence, or accident, or incorrectly used in combination with other substances. Wear items, such as V-Belts, filters, etc..., are not included as covered parts under this Warranty. Reimbursement for labor for removing and/or re-installing replacement parts is included in this Warranty for a period of 30 days from field start-up or 90 days from Shipment, whichever comes first. NAKS, Inc. is responsible to determine the amount of labor reimbursement allowed, based upon the circumstances for each installation. Labor cost reimbursement must be approved by NAKS, Inc in writing prior to the work being performed. You assume all risks and liability for results of use of all Products.

Evaporative cooling pads are warranted to be free of defects in materials and workmanship for a period of two years from date of shipment provided same have been properly handled, stored, installed, serviced, maintained and operated; and further, not subjected to excessive heat, corrosive agents or chemicals, or mechanical abuse that may cause tearing, crushing or undue deterioration, nor used on a system or in a manner other than that for which it was designed as explained in the Order.

**LIMITATION OF REMEDY AND DAMAGES.** All claims under this warranty must be made in writing and delivered by U.S. Mail to:

North American Kitchen Solutions

172 Reaser Court

Elyria, OH 44035

Attn: WARRANTY CLAIMS DEPARTMENT

All Product claims must be made within 15 days after discovery of the defect and prior to the expiration of two years from the date of shipment. Claims made beyond that period are barred. Within 30 days after receipt of a timely claim, NAKS shall have the option either to inspect the Product at its location or request its return to NAKS at your expense. NAKS shall replace, or at its option repair, free of charge, any Product it determines to be defective, and it shall ship the repaired or replacement product to you F.O.B. point of shipment; provided, however, if in NAKS' judgment circumstances are such to prohibit repair or replacement to remedy the warranted defects, your sole and exclusive remedy shall be a refund of any part of the invoice price, paid to NAKS, for the defective Product or part.

NAKS is not responsible for the cost of removal of the defective Product or part, damages due to removal, or any expenses incurred in shipping the Product, or the installation of the repaired or replaced Product or part.

The warranties set forth above do not apply to any components, accessories, parts or attachments manufactured by other manufacturers; such being subject to the manufacturer's warranty, if any. To the extent not prohibited by the manufacturer's warranty, NAKS shall pass to you such manufacturer's warranty.

THIS WARRANTY IS IN LIEU OF ALL OTHER WARRANTIES, EXPRESS OR IMPLIED, ARISING BY LAW OR OTHERWISE, INCLUDING WITHOUT LIMITATION THE IMPLIED WARRANTIES OF MERCHANTABILITY AND FITNESS FOR A PARTICULAR PURPOSE, WHICH ARE HEREBY EXPRESSLY DISCLAIMED AND WAIVED. THIS WARRANTY CONSTITUTES NAKS SOLE AND EXCLUSIVE WARRANTY FOR DEFECTIVE GOODS AND PURCHASER'S SOLE AND EXCLUSIVE REMEDY FOR DEFECTIVE PRODUCTS.

No employee, agent, dealer, or other person is authorized to give any warranties on behalf of NAKS or to assume for it any other liability in connection with any of its products except in writing and signed by an officer of NAKS.

**LIMITATION OF LIABILITY.** NAKS' cumulative liability to you and any other persons for all claims in any way relating to or arising out of the Products, including, but not limited to, any cause of action sounding in contract, tort, or strict liability, shall not exceed the total amount of the purchase price paid for those Products which are the subject of any such claim. This limitation of liability is intended to apply without regard to whether other provisions of this agreement have been breached or have proven ineffective even if NAKS has been advised of the possibility of such claims or demands. In no event shall NAKS be liable to you or any other person for any loss of profits or any incidental, special, exemplary, or consequential damages for any claims or demands brought by you or such other persons. BECAUSE SOME JURISDICTIONS DO NOT ALLOW THE EXCLUSION OR LIMITATION OF LIABILITY FOR CONSEQUENTIAL OR INCIDENTAL DAMAGES, THIS LIMITATION MAY NOT APPLY TO YOU.

NAKS' maximum liability to you and to any end user is as set forth above. NAKS makes no warranty to anyone for any products not manufactured by it and shall have no liability for any use or installation of any products (whether manufactured by NAKS or other manufacturers) not specifically authorized by this sale. You acknowledge various warnings by NAKS regarding the Products and its installation and use. If NAKS incurs any claims, lawsuits, settlements, or expenses (including attorney fees) for any loss, injury, death or property damage including, but not limited to, claims arising out of your or any end user's installation or use of the Products, you agree to indemnify and hold NAKS harmless.

**REPLACEMENT PARTS.** If replacement parts are ordered, purchaser warrants that the original components in which these replacement parts will be placed are in satisfactory working condition, and when said replacement parts are installed, the resultant installation will operate in a safe manner, at speeds and temperatures for which the original product was purchased.

**TECHNICAL ADVICE AND RECOMMENDATIONS, DISCLAIMER.** Notwithstanding any past practice or dealings or any custom of the trade, sales shall not include the furnishing of technical advice or assistance or system design. Any such assistance shall be at NAKS' sole option and may be subject to additional charge(s).

NAKS assumes no obligation or liability on account of any recommendations, opinions or advice as to the choice, installation or use of Products. Any such recommendations, opinions or advice are given and shall be accepted at your and the end-user's risk and shall not constitute any warranty or guarantee of such Products or their performance.

2017 © North American Kitchen Solutions • 172 Reaser Court, Elyria, OH 44035

Toll Free: (800)715-1014

customerservice@naksinc.com