

# HOODMART®

YOUR ONE STOP HOOD SHOP

172 REASER COURT  
 ELYRIA, OHIO 44035  
 FAX: 1-800-716-1214  
 TOLL FREE : 1-800-715-1014  
 www.hoodmart.com  
 sales@hoodmart.com

## Pizza Hood System

### Canopy Type I with Make-Up Air Supply

Hood General Specifications: 10' L x 60" D

Hoods are built in accordance with NFPA 96, NSF Specifications and conforms to the U.L. 710 standards

- Hoods are constructed of 18 gauge steel
- All joints are welded liquid tight, without seams
- Grease Filters are 20" baffle type which carry a U.L. listing and constructed of light weight aluminum
- Grease trough is made to receive grease extracted by the filter
- Each Grease trough is equipped with a stainless steel cup
- Notes: Factory does not cut holes in hood  
 Hoods 10' and Larger Receive 6 Hanger Brackets Total

### Available In:

- **Deluxe:** All Stainless Steel
- **Hybrid:** Front and Sides are Stainless Steel and Top and Back are Aluminized

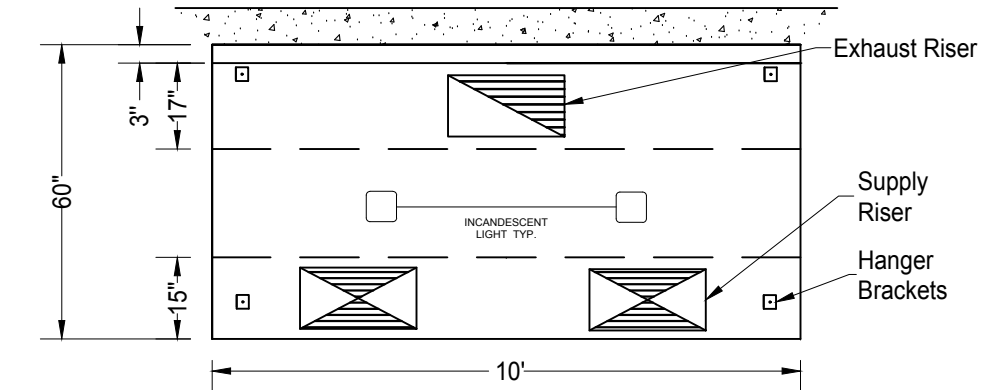

It is the responsibility of the architect/owner to ensure that the hood clearance from limited-combustible and combustible materials is in compliance with local code requirements

